

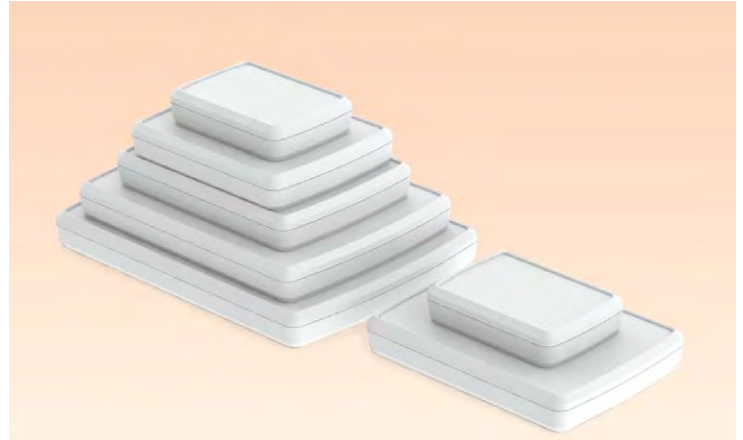



POCKET SIZE ENCLOSURES

Page 12



TABLET ENCLOSURES

Page 15

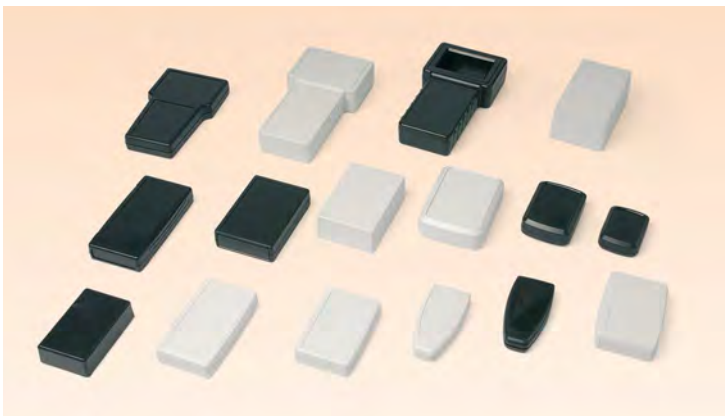

HAND HELD ENCLOSURES

Page 16



RASPBERRY PI ENCLOSURES

Page 21

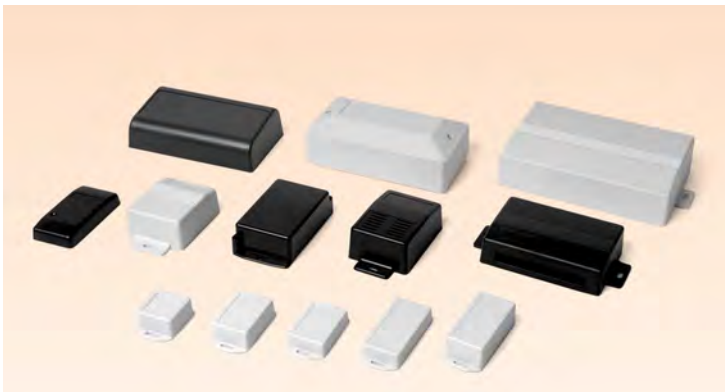

WALL MOUNT ENCLOSURES

Page 22



WORK MACHINE CONTROL ENCLOSURE

Page 28



PLUG CASES

Page 29

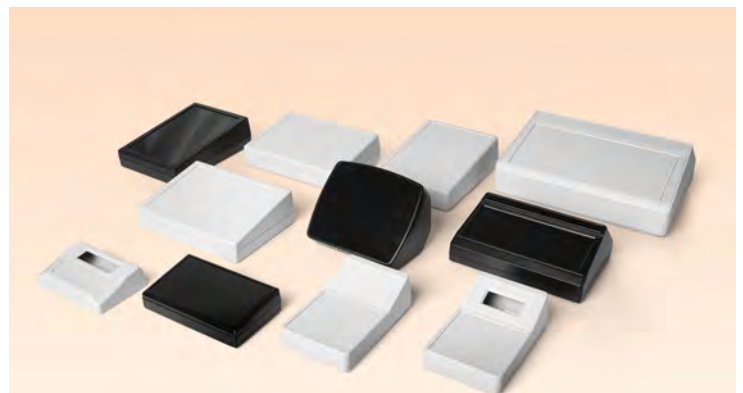

SLOPED DESKTOP ENCLOSURES

Page 30



PLUSH-MOUNTED ENCLOSURES

Page 33



DIN RAIL ENCLOSURES

Page 34



DIN PANEL ENCLOSURES

Page 40



OPERATOR PANEL ENCLOSURES

Page 46

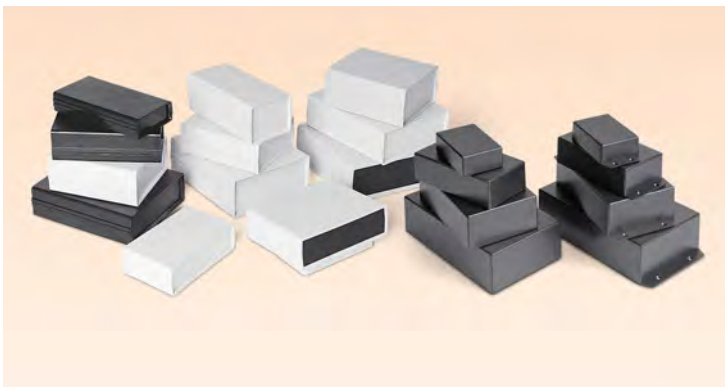

PLASTIC PROJECT ENCLOSURES

Page 48

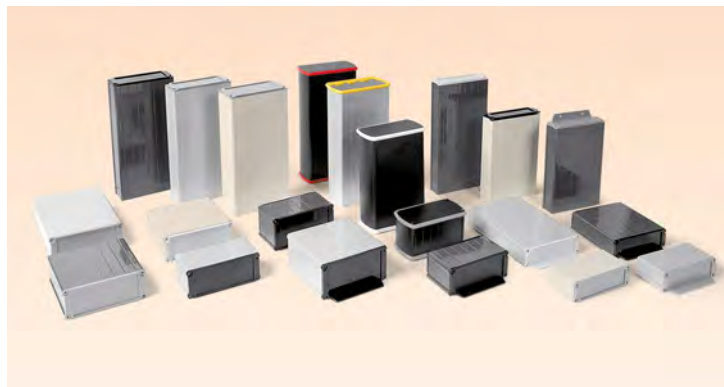

ALUMINIUM PROFILE ENCLOSURES

Page 50



METAL PROJECT ENCLOSURES

Page 52

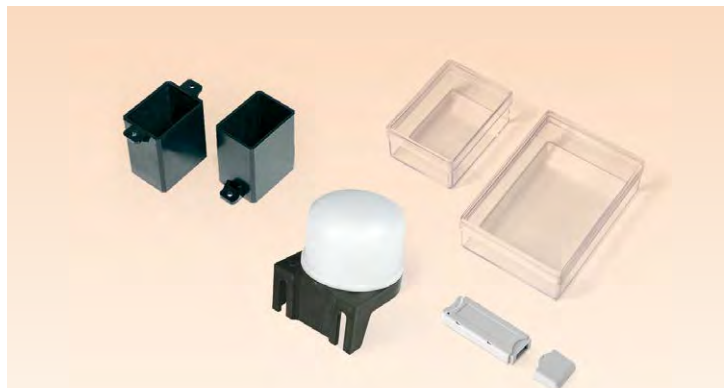

OTHER ENCLOSURES

Page 53



MODULAR METAL ENCLOSURES

Page 54

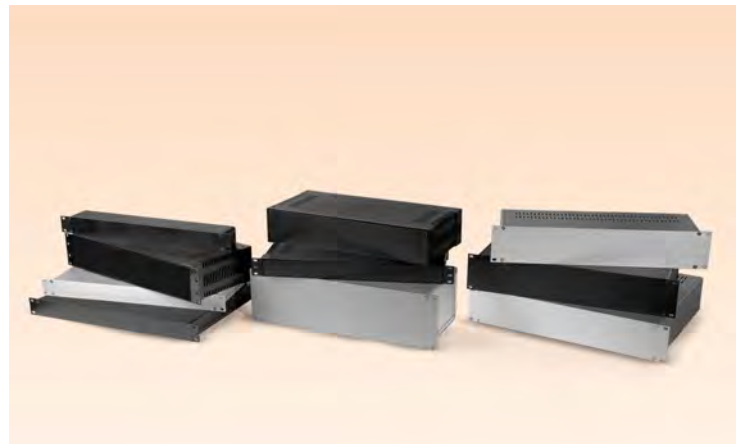

19" RACK ENCLOSURES

Page 56



ALUMINIUM LABORATORY ENCLOSURES

Page 59



DESKTOP LABORATORY ENCLOSURES

Page 60

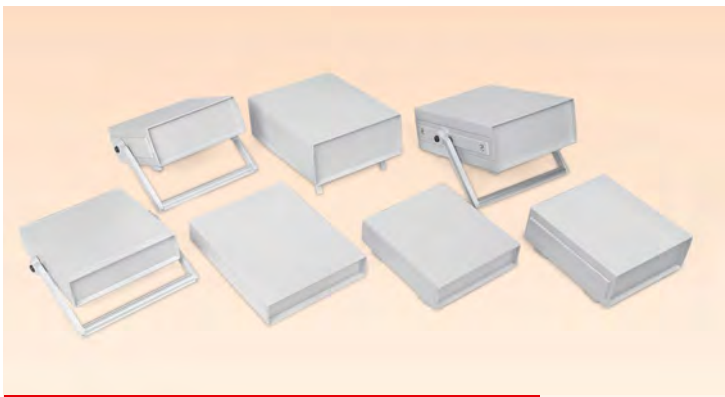

PLASTIC LABORATORY ENCLOSURES

Page 63



SLOPED LABORATORY ENCLOSURES

Page 64



POWER SUPPLY ENCLOSURES

Page 67



IP-67 PLASTIC ENCLOSURES

Page 68



IP-67 ENCLOSURE WITH CABLE GLAND Page 73



IP-67 HEAVY DUTY ENCLOSURES Page 74



IP-67 FLANGED HEAVY DUTY ENCLOSURES Page 75



IP-65 DIE CAST ENCLOSURES Page 76



DIE CAST ENCLOSURES Page 77

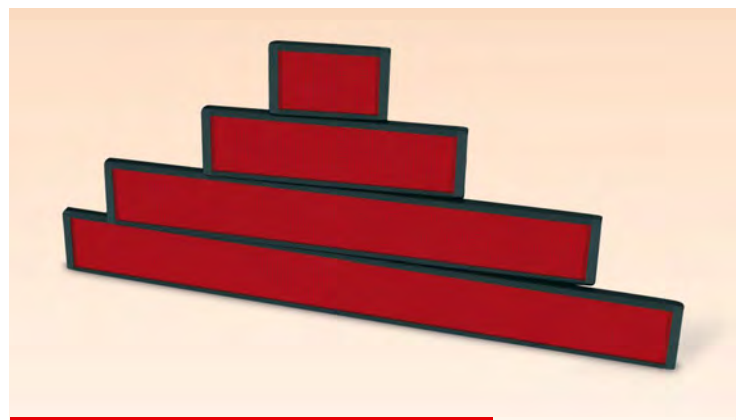

PROFILE DISPLAY ENCLOSURES Page 78

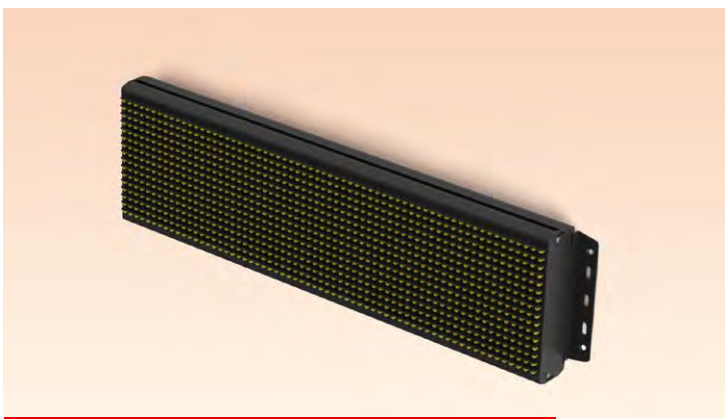

P10 PANEL DISPLAY ENCLOSURES Page 79

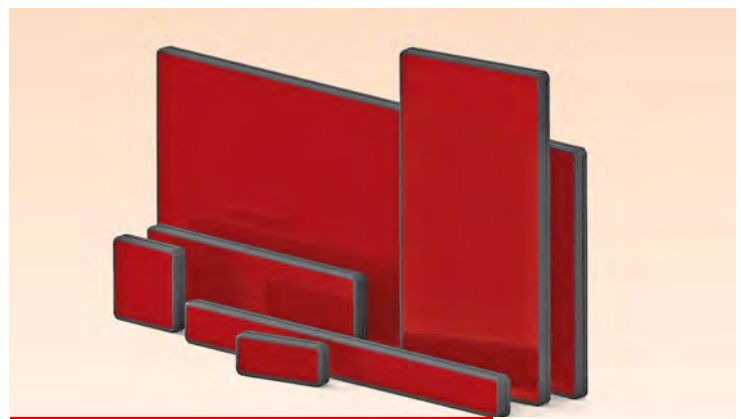

MODULAR DISPLAY ENCLOSURES Page 80

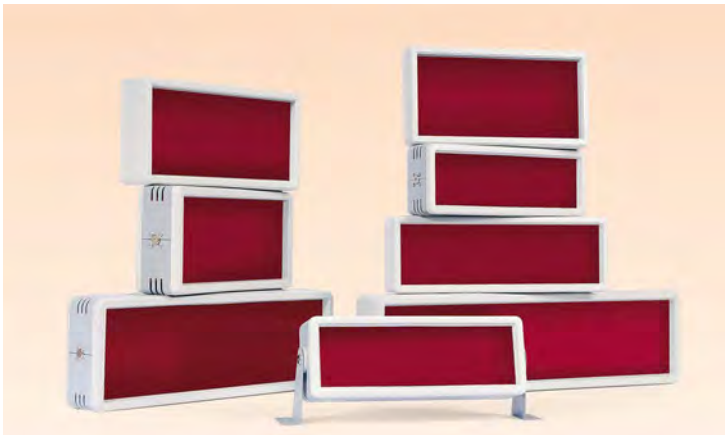

DISPLAY ENCLOSURES

Page 81



PLASTIC CASES

Page 83



BATTERY HOLDERS

Page 84



COIN CELL HOLDERS

Page 89



COMPONENTS

Page 91



CABLE GLANDS

Page 92



STANDOFFS

Page 94

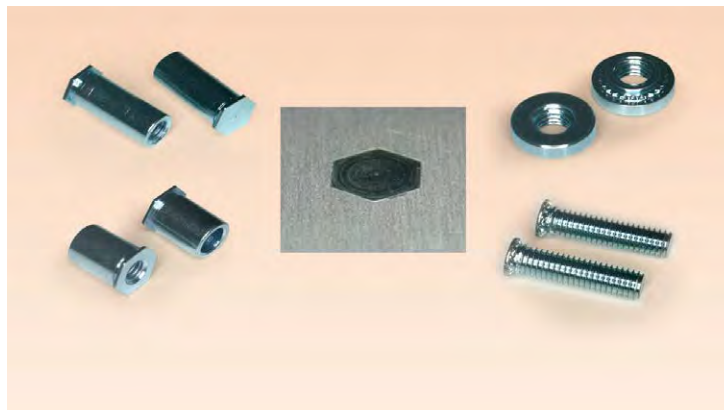

CLINCHING STANDOFFS & NUTS

Page 111

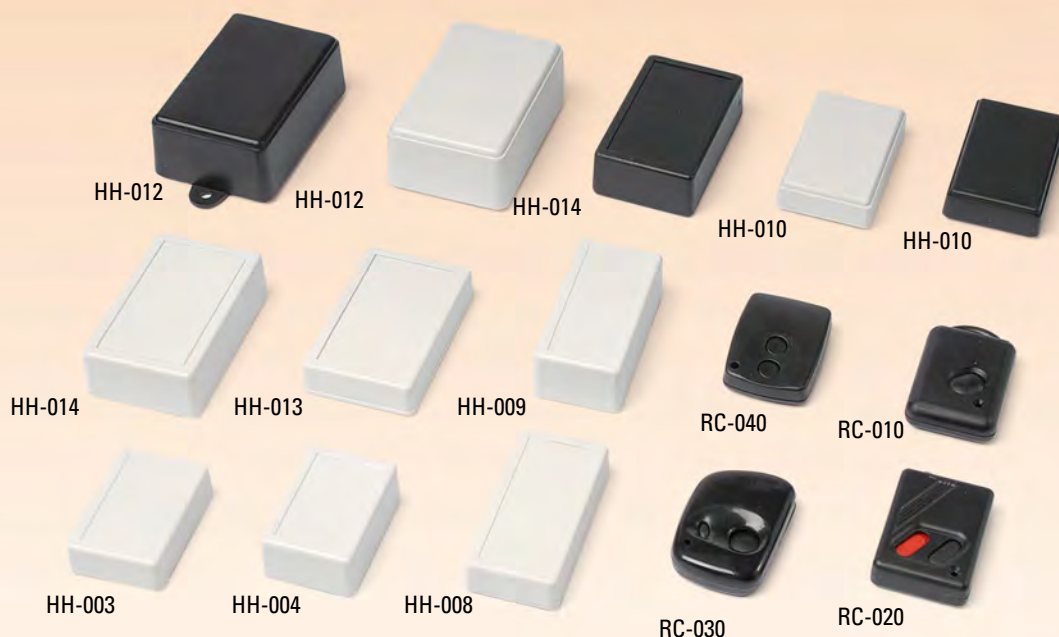

POCKET SIZE ENCLOSURES



RC-010

RC-020

RC-030

RC-010

ONE BUTTON
35 x 50 mm

REMOTE CONTROL ENCLOSURE

RC-020

TWO BUTTONS
35 x 50 mm

MATERIAL	ABS
COLOR	BLACK
PACKAGING	50 PCS/BOX

RC-030

TWO BUTTONS OVAL
37 x 52 mm

BUTTON COLOR OPTIONS
RED / BLACK

SUITABLE ACCESSORIES

A-934 PHOSPHOR BRONZE BATTERY CONTACT

RC-040-A

TWO BUTTONS
50 x 36 x 14 mm

REMOTE CONTROL ENCLOSURE

RC-040-B

ONE (UP) BUTTON
50 x 36 x 14 mm

MATERIAL	ABS
COLOR	BLACK
PACKAGING	50 PCS/BOX

RC-040-C

ONE (DOWN) BUTTON
50 x 36 x 14 mm

SUITABLE ACCESSORIES

BC-2002 CR-2032 BATTERY HOLDER

RC-040-D

NO BUTTONS
50 x 36 x 14 mm



RC-040



HH-002

HH-002

35 x 35 x 20 mm

POCKET SIZE ENCLOSURE

MATERIAL	ABS
COLOR	BLACK / LIGHT GRAY
PACKAGING	20 PCS/BOX

• WALL MOUNTABLE MODELS Page 22-23

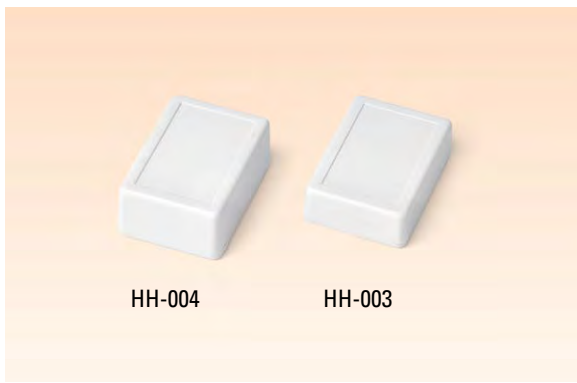

HH-004

HH-003

HH-003

35 x 50 x 15 mm

POCKET SIZE ENCLOSURE

HH-004

35 x 50 x 20 mm

MATERIAL	ABS
COLOR	BLACK / LIGHT GRAY
PACKAGING	20 PCS/BOX

• WALL MOUNTABLE MODELS Page 22-23



HH-005

HH-005

50 x 50 x 15 mm

POCKET SIZE ENCLOSURE

MATERIAL	ABS
COLOR	BLACK / LIGHT GRAY
PACKAGING	20 PCS/BOX

• WALL MOUNTABLE MODELS Page 22-23

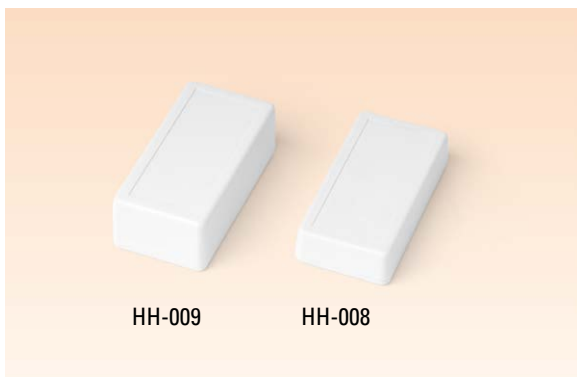

HH-009

HH-008

HH-008

35 x 70 x 15 mm

POCKET SIZE ENCLOSURE

HH-009

35 x 70 x 23 mm

MATERIAL	ABS
COLOR	BLACK / LIGHT GRAY
PACKAGING	20 PCS/BOX

• WALL MOUNTABLE MODELS Page 22-23



HH-013

HH-013

45 x 72,5 x 15 mm

POCKET SIZE ENCLOSURE

MATERIAL	ABS
COLOR	BLACK / LIGHT GRAY
PACKAGING	20 PCS/BOX

• WALL MOUNTABLE MODELS Page 22-23



HH-014

HH-014

45 x 72,5 x 23 mm

POCKET SIZE ENCLOSURE

MATERIAL	ABS
COLOR	BLACK / LIGHT GRAY
PACKAGING	20 PCS/BOX

• WALL MOUNTABLE MODELS Page 22-23

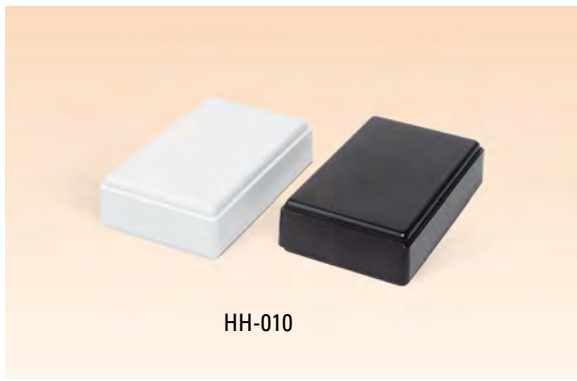

HH-010

41 x 66 x 16 mm

POCKET SIZE ENCLOSURE

MATERIAL	ABS	SUITABLE ACCESSORIES
COLOR	LIGHT GRAY / BLACK	A-58 CLICK WALL MOUNT
PACKAGING	50 PCS/BOX	A-59 WALL MOUNT EAR

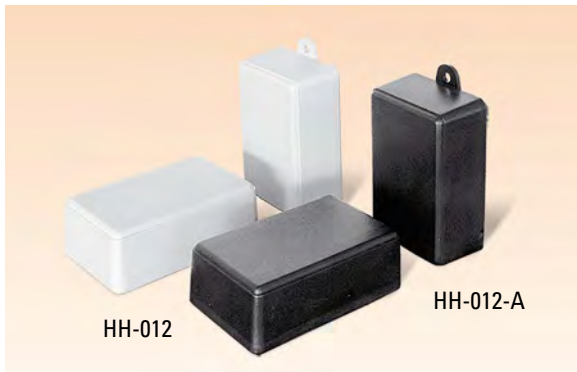

HH-012

STANDARD
54 x 84 x 32 mm

HAND HELD ENCLOSURE

HH-012-A

WALL MOUNTABLE

SUITABLE ACCESSORIES

MATERIAL	ABS	A-58 CLICK WALL MOUNT
COLOR	LIGHT GRAY / BLACK	A-59 WALL MOUNT EAR
PACKAGING	50 PCS/BOX	



HH-018

85 x 85 x 23 mm

HAND HELD ENCLOSURE

MATERIAL	ABS	SUITABLE ACCESSORIES
COLOR	LIGHT GRAY / BLACK	A-58 CLICK WALL MOUNT
PACKAGING	20 PCS/BOX	A-59 WALL MOUNT EAR

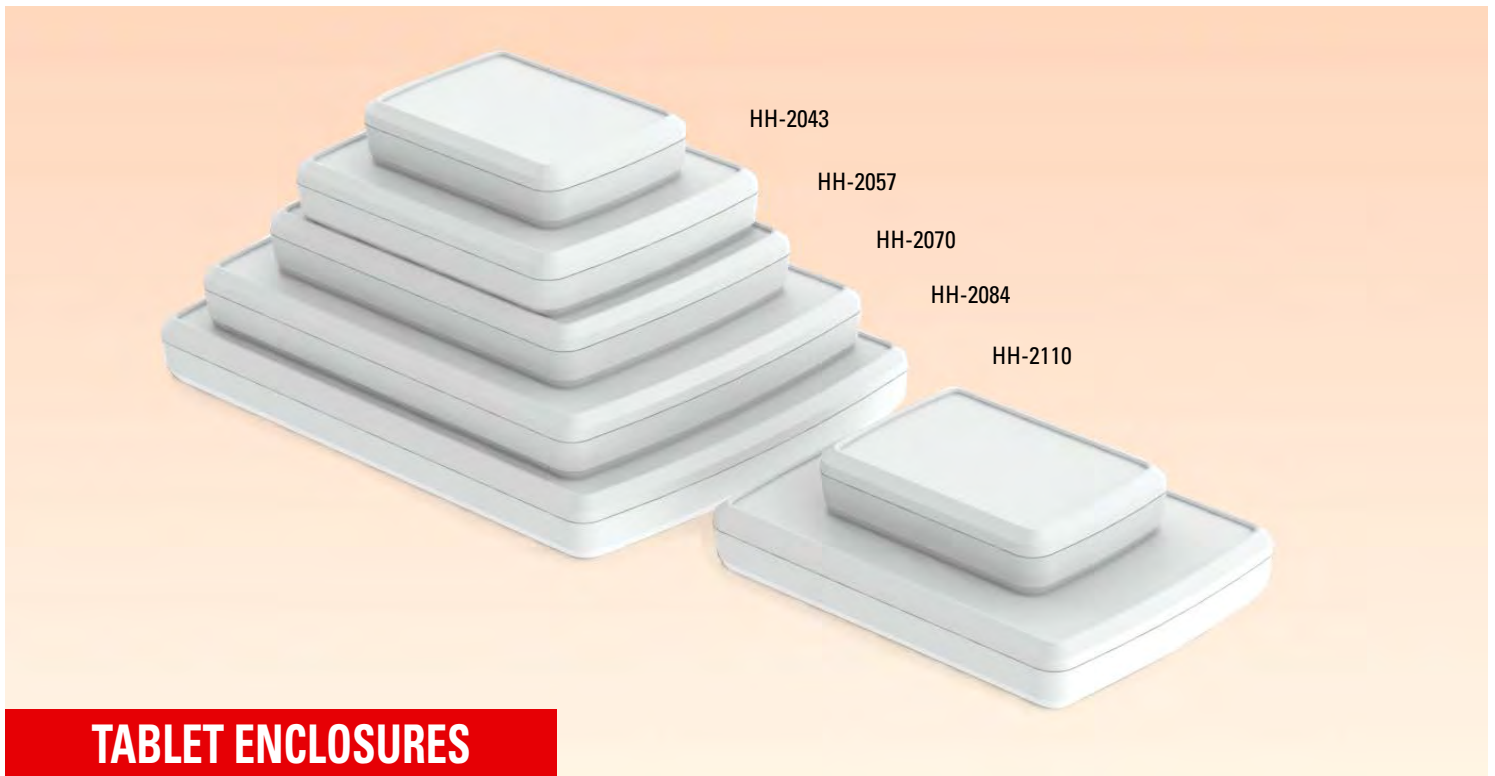

TABLET ENCLOSURES

- Low profile ergonomic design for nice handling
- Light gray and black color options
- Impact resistant ABS material
- Suitable for 4.3" , 5.7" , 7" , 8.4" & 11" LCD modules
- Wall mountable with suitable accessories

Code	Width (mm)	Length (mm)	Height (mm)	Compatible LCD Module Size
HH-2043	140	100	32	4.3"
HH-2057	190	150	32	5.7"
HH-2070	221	161	32	7"
HH-2084	279	206	32	8.4"
NEW HH-2110	322	232	32	11"

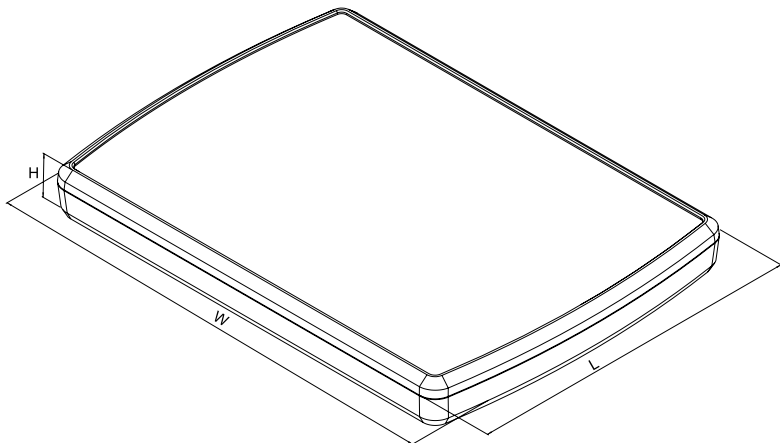

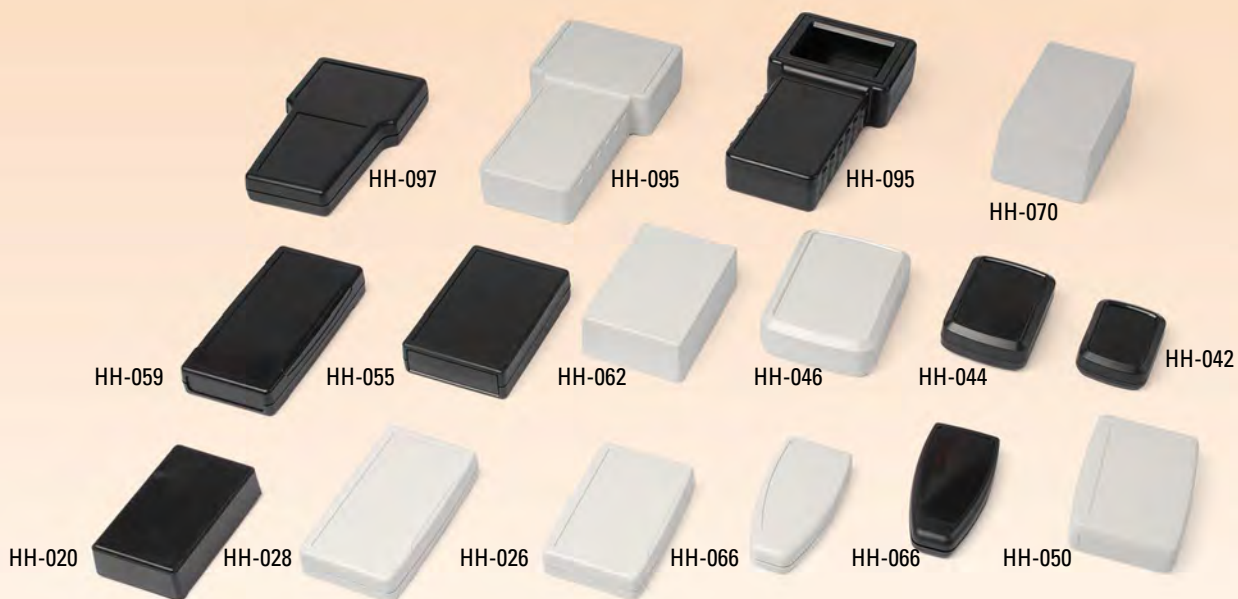

HAND HELD ENCLOSURES



HH-020

HH-020

58 x 92 x 27 mm

HAND HELD ENCLOSURE

MATERIAL	ABS	SUITABLE ACCESSORIES
COLOR	LIGHT GRAY / BLACK	A-58 CLICK WALL MOUNT
PACKAGING	50 PCS/BOX	A-59 WALL MOUNT EAR



HH-026

HH-026

100 x 68 x 22 mm

REMOTE CONTROL ENCLOSURE WITH BATTERY COMPARTMENT

MATERIAL	ABS	SUITABLE ACCESSORIES
COLOR	LIGHT GRAY / BLACK	BATTERY CONTACT SET
BATTERY HOLDER	2xAA or 9V APPLICABLE	A-58 CLICK WALL MOUNT
PACKAGING	50 PCS/BOX	A-190 BELT CLIPS
		A-57 TILTING FOOT



HH-028

HH-028

115 x 68 x 22 mm

REMOTE CONTROL ENCLOSURE WITH BATTERY COMPARTMENT

MATERIAL	ABS	SUITABLE ACCESSORIES
COLOR	LIGHT GRAY / BLACK	BATTERY CONTACT SET
BATTERY HOLDER	3xAA Or 9V APPLICABLE	A-58 CLICK WALL MOUNT
PACKAGING	50 PCS/BOX	A-190 BELT CLIPS
		A-57 TILTING FOOT



HH-042

69,5 x 50,5 x 21 mm

HAND HELD ENCLOSURE

MATERIAL	ABS	SUITABLE ACCESSORIES
COLOR	LIGHT GRAY / BLACK	A-58 CLICK WALL MOUNT
PACKAGING	50 PCS/BOX	A-59 WALL MOUNT EAR
		A-190 BELT CLIPS



HH-044

88,5 x 63 x 27,5 mm

HAND HELD ENCLOSURE

MATERIAL	ABS	SUITABLE ACCESSORIES
COLOR	LIGHT GRAY / BLACK	A-58 CLICK WALL MOUNT
PACKAGING	50 PCS/BOX	A-59 WALL MOUNT EAR
		A-190 BELT CLIPS



HH-045

95 x 62 x 22 mm

REMOTE CONTROL ENCLOSURE WITH BATTERY COMPARTMENT

MATERIAL	ABS	SUITABLE ACCESSORIES
COLOR	LIGHT GRAY / BLACK	BATTERY CONTACT SET
BATTERY HOLDER	2xAAA APPLICABLE	A-58 CLICK WALL MOUNT
PACKAGING	50 PCS/BOX	A-59 WALL MOUNT EAR
		A-190 BELT CLIPS



HH-046

115 x 83 x 32 mm

HAND HELD ENCLOSURE

MATERIAL	ABS	SUITABLE ACCESSORIES
COLOR	LIGHT GRAY / BLACK	A-58 CLICK WALL MOUNT
PACKAGING	50 PCS/BOX	A-59 WALL MOUNT EAR
		A-190 BELT CLIPS
		A-57 TILTING FOOT



HH-047

116,5 x 104,5 x 32 mm

HAND HELD ENCLOSURE

MATERIAL	ABS	SUITABLE ACCESSORIES
COLOR	LIGHT GRAY / BLACK	A-58 CLICK WALL MOUNT
PACKAGING	50 PCS/BOX	A-59 WALL MOUNT EAR
		A-190 BELT CLIPS

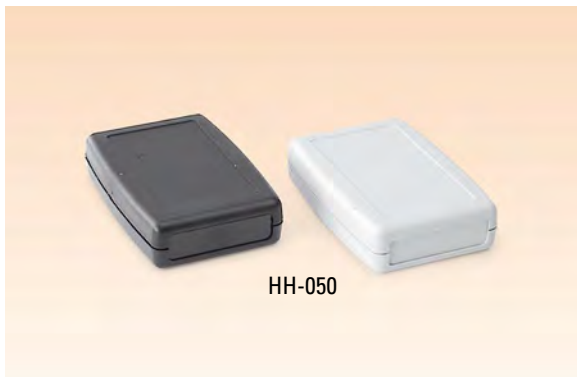

HH-050

72 x 104 x 26 mm

HAND HELD ENCLOSURE

MATERIAL	ABS
COLOR	LIGHT GRAY / BLACK
PACKAGING	10 PCS/BOX

SUITABLE ACCESSORIES
A-58 CLICK WALL MOUNT
A-190 BELT CLIPS
A-57 TILTING FOOT



HH-052

75 x 105 x 26,4 mm

REMOTE CONTROL ENCLOSURE WITH BATTERY COMPARTMENT

MATERIAL	ABS
COLOR	LIGHT GRAY
BATTERY HOLDER	2xAA or 9V APPLICABLE

SUITABLE ACCESSORIES
A-932 BATTERY CONTACT SET
A-204 BATTERY CONTACT
A-190 BELT CLIP
A-57 TILTING FOOT

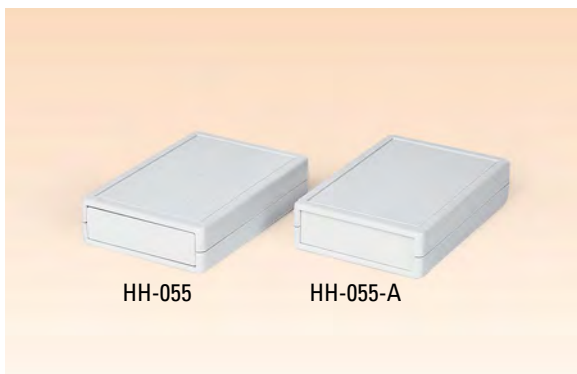

HH-055

STANDARD
76 x 112 x 26 mm

HAND HELD ENCLOSURE

HH-055-B

CURVED PANEL

PANEL OPTIONS
FLAT PANEL / CURVED PANEL

MATERIAL	ABS
COLOR	LIGHT GRAY / BLACK
PACKAGING	10 PCS/BOX

SUITABLE ACCESSORIES
A-58 CLICK WALL MOUNT
A-59 WALL MOUNT EAR
A-190 BELT CLIP
A-57 TILTING FOOT



HH-058

135 x 70 x 24 mm

REMOTE CONTROL ENCLOSURE WITH BATTERY COMPARTMENT

MATERIAL	ABS
COLOR	LIGHT GRAY
BATTERY HOLDER	2xAA or 9V APPLICABLE

SUITABLE ACCESSORIES
A-932 2xAA BATTERY CONTACT SET
A-204 BATTERY CONTACT
A-190 BELT CLIPS
A-57 TILTING FOOT



HH-059

133,5 x 70 x 24 mm

REMOTE CONTROL ENCLOSURE WITH BATTERY COMPARTMENT

MATERIAL	ABS
COLOR	LIGHT GRAY / BLACK
BATTERY HOLDER	2xAA or 9V APPLICABLE
PACKAGING	50 PCS/BOX

SUITABLE ACCESSORIES
BATTERY CONTACT SET
A-58 CLICK WALL MOUNT
A-190 BELT CLIPS
A-57 TILTING FOOT

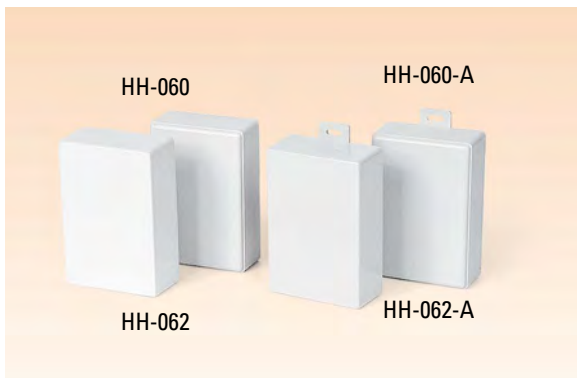

HH-060	75 x 110 x 36 mm (2 SCREWS)	HAND HELD ENCLOSURE	
HH-062	75 x 110 x 36 mm (4 SCREWS)	MATERIAL	ABS
HH-060-A	WITH EAR (2 SCREWS)	COLOR	LIGHT GRAY / BLACK
HH-062-A	WITH EAR (4 SCREWS)	PACKAGING	50 PCS/BOX

• HH-062 IS RECOMMENDED FOR NEW DESIGNS



HH-066	STANDARD 100 x 50 x 18 mm	HAND HELD ENCLOSURE	
MATERIAL	ABS	SUITABLE ACCESSORIES	
COLOR	LIGHT GRAY / BLACK	A-190 BELT CLIPS	
PACKAGING	50 PCS/BOX	A-366 WALL MOUNT KIT NEW	

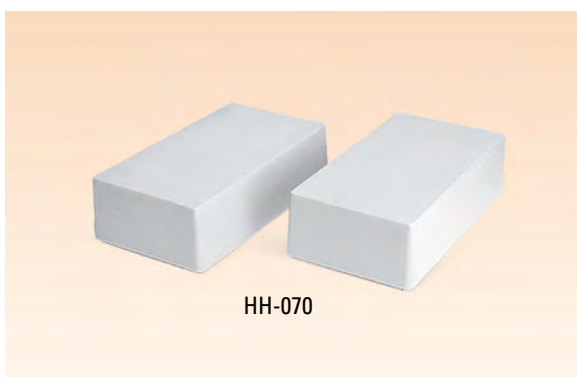

HH-070	76 x 136 x 50 mm	HAND HELD ENCLOSURE	
MATERIAL	ABS	SUITABLE ACCESSORIES	
COLOR	LIGHT GRAY / BLACK	A-58 CLICK WALL MOUNT	
PACKAGING	20 PCS/BOX	A-59 WALL MOUNT EAR	

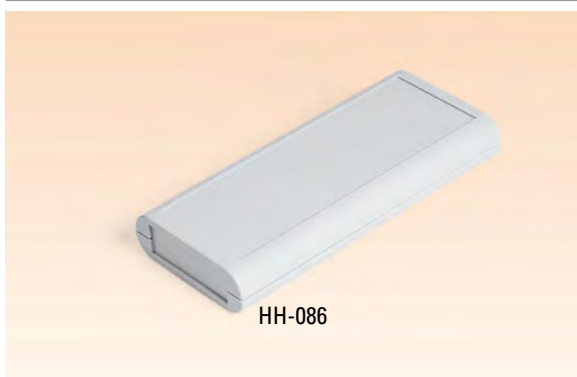

HH-086	177 x 77 x 25 mm	HAND HELD ENCLOSURE	
MATERIAL	ABS	SUITABLE ACCESSORIES	
COLOR	LIGHT GRAY	A-58 CLICK WALL MOUNT	
PACKAGING	1 PCS/BOX	A-190 BELT CLIPS	



HH-087	65 x 182 x 28 mm	REMOTE CONTROL ENCLOSURE WITH BATTERY COMPARTMENT	
MATERIAL	ABS	SUITABLE ACCESSORIES	
COLOR	LIGHT GRAY	A-935 4xAA BATTERY CONTACT SET	
BATTERY HOLDER	4xAA	A-190 BELT CLIPS	



HH-088

HH-088

172 x 77 x 28 mm

HAND HELD ENCLOSURE

MATERIAL	ABS	SUITABLE ACCESSORIES
COLOR	LIGHT GRAY / BLACK	A-58 CLICK WALL MOUNT
PACKAGING	10 PCS/BOX	A-59 WALL MOUNT EAR



HH-097

HH-097

160 x 94 x 25 mm

HAND HELD ENCLOSURE

MATERIAL	ABS	SUITABLE ACCESSORIES
COLOR	LIGHT GRAY / BLACK	A-58 CLICK WALL MOUNT
PACKAGING	10 PCS/BOX	A-190 BELT CLIPS
		A-57 TILTING FOOT



HH-095-A

HH-095

HH-095

STANDARD
105 x 201 x 41 mm

REMOTE CONTROL ENCLOSURE

HH-095-A

W/BATTERY HOLDER
105 x 201 x 41 mm

MATERIAL	ABS
COLOR	LIGHT GRAY / BLACK
PANEL	GRAY / CLEAR / BLACK
BATTERY HOLDER	2xAA or 9V APPLICABLE
PACKAGING	10 PCS/BOX

SUITABLE ACCESSORIES
A-932 2xAA BATTERY CONTACT SET
A-204 9V BATTERY CONTACT
A-190 BELT CLIPS



HH-096

HH-096

STANDARD
160 x 94 x 25 mm

REMOTE CONTROL ENCLOSURE WITH BATTERY COMPARTMENT

HH-096-A

W/BATTERY HOLDER
160 x 94 x 25 mm

SUITABLE ACCESSORIES
A-937 4xAAA BATTERY CONTACT SET
A-190 BELT CLIPS
A-57 TILTING FOOT

MATERIAL	ABS
COLOR	LIGHT GRAY
BATTERY HOLDER	4xAAA BATTERY HOLDER

IMPORTED



A-662

A-662

YCB PLS COMBO PCB SCREW
2,5 x 5 mm

PCB MOUNTING SCREW

SURFACE	NICKEL PLATING	RECOMMENDED PCB HOLE DIA	3mm
SCREW HEAD	COMBO (FLAT / PHILIPS)	RECOMMENDED PCB PAD DIA	5mm
THREAD TYPE	PLASTIC	PLASTIC HOLE DIA	1.8 - 2.1 mm
PCS IN PACK	500 PCS/BOX		



RASPBERRY PI ENCLOSURES



PI-312

PI-312

63 x 113 x 29 mm

ENCLOSURE FOR RASPBERRY PI MODEL B

MATERIAL	PC / ABS
COLOR	BLACK / WHITE / RED / CLEAR
PACKAGING	1 PCS/BOX

- COMPATIBLE WITH RASPBERRY PI MODEL B
- NOT COMPATIBLE WITH RASPBERRY PI MODEL B+, MODEL A+, MODEL 2/3
- RASPBERRY PI IS A TRADE MARK OF RASPBERRY PI FOUNDATION UK



PI-314

PI-314

63 x 93 x 25 mm

ENCLOSURE FOR RASPBERRY PI 2 & 3

MATERIAL	PC
COLOR	BLUE / CLEAR / BLACK / WHITE / GRAY
PACKAGING	1 PCS/BOX

- COMPATIBLE WITH RASPBERRY PI 2 & 3
- RASPBERRY PI IS A TRADE MARK OF RASPBERRY PI FOUNDATION UK

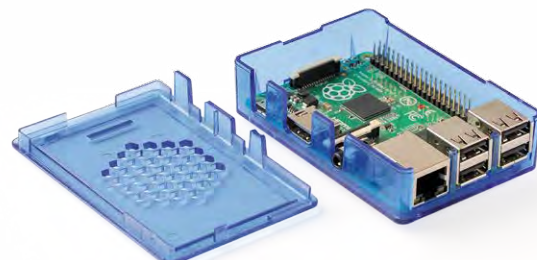
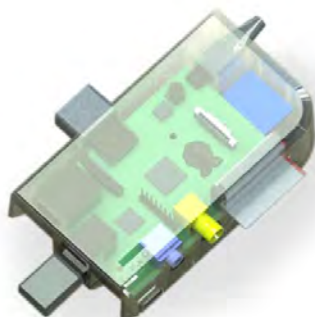

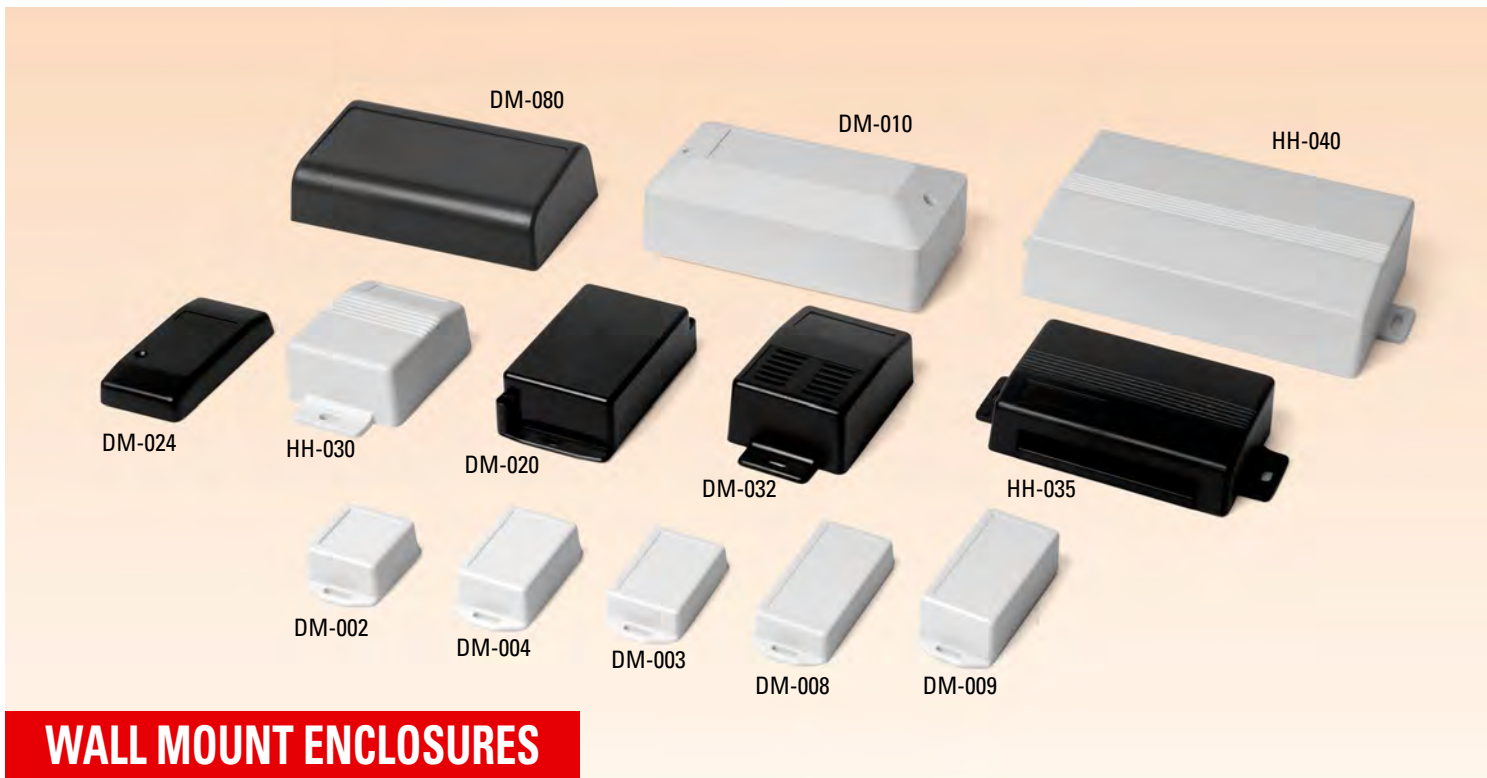

WALL MOUNT ENCLOSURES



DM-002	35 x 50 x 20 mm	WALL MOUNT ENCLOSURE
MATERIAL	ABS	
COLOR	LIGHT GRAY / BLACK	
PACKAGING	20 PCS/BOX	

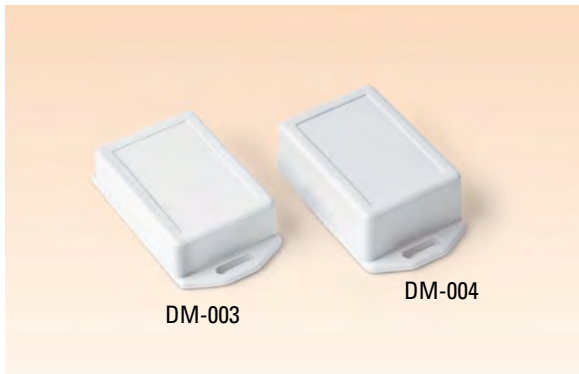

DM-003	35 x 65 x 15,3 mm	WALL MOUNT ENCLOSURE
DM-004	35 x 65 x 20,3 mm	
MATERIAL	ABS	
COLOR	LIGHT GRAY / BLACK	
PACKAGING	20 PCS/BOX	



DM-005	50 x 67,5 x 15 mm	WALL MOUNT ENCLOSURE
MATERIAL	ABS	
COLOR	LIGHT GRAY / BLACK	
PACKAGING	20 PCS/BOX	

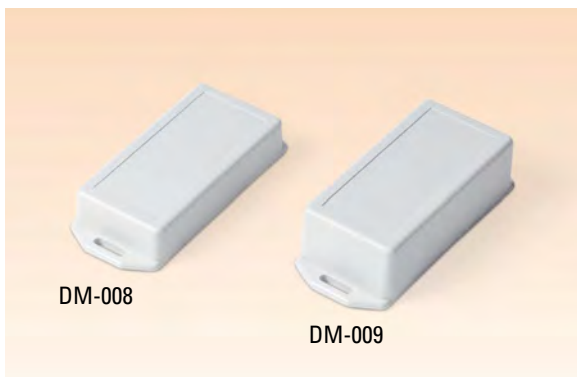

DM-008 35 x 85 x 15,3 mm **WALL MOUNT ENCLOSURE**

DM-009 35 x 85 x 23,3 mm

MATERIAL ABS
 COLOR LIGHT GRAY / BLACK
 PACKAGING 20 PCS/BOX



DM-013 87,5 x 45 x 15.3 mm **WALL MOUNT ENCLOSURE**

DM-014 87,5 x 45 x 23,3 mm

MATERIAL ABS
 COLOR LIGHT GRAY / BLACK
 PACKAGING 20 PCS/BOX



DM-021 72 x 19 x 20 mm **WALL MOUNT ENCLOSURE**

SENSOR ENCLOSURE

MATERIAL ABS
 COLOR BLACK / LIGHT GRAY
 PACKAGING 20 PCS/BOX



DM-024 44 x 84 x 15 mm **WALL MOUNT ENCLOSURE**

ENCLOSURE FOR PROXIMITY CARD READER

MATERIAL ABS
 COLOR BLACK / LIGHT GRAY
 PACKAGING 20 PCS/BOX



DM-025 102,7 x 48,2 x 22 mm **WALL MOUNT ENCLOSURE**

ENCLOSURE FOR PROXIMITY CARD READER

MATERIAL ABS
 COLOR BLACK / WHITE / DARK GRAY
 PACKAGING 20 PCS/BOX

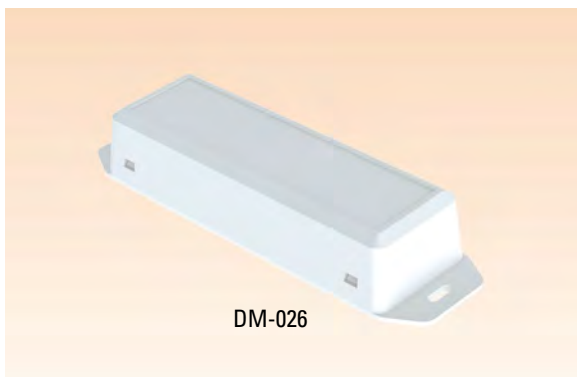

DM-026

DM-026

150 x 43 x 28 mm

WALL MOUNT ENCLOSURE

MATERIAL	ABS
COLOR	LIGHT GRAY / BLACK
PACKAGING	20 PCS/BOX



HH-030

HH-030-K

HH-030

61 x 75 x 33 mm

WALL MOUNT ENCLOSURE

HH-030-K

W/O TERMINAL WINDOW

HH-030-A

W/ TERMINAL WINDOW

MATERIAL	ABS
COLOR	LIGHT GRAY / BLACK
PACKAGING	50 PCS/BOX



DM-032

DM-032

61 x 86 x 32 mm

WALL MOUNT ENCLOSURE

DM-032-K

W/O TERMINAL WINDOW

DM-032-A

W/ TERMINAL WINDOW

MATERIAL	ABS
COLOR	LIGHT GRAY / BLACK
PACKAGING	20 PCS/BOX

• OPTIONAL VENTILATION HOLES ON TOP

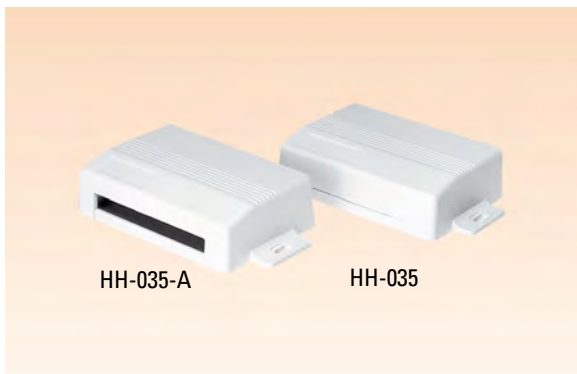

HH-035-A

HH-035

HH-035

143 x 76 x 32 mm

WALL MOUNT ENCLOSURE

HH-035-K

W/O TERMINAL WINDOW

HH-035-A

W/ TERMINAL WINDOW

MATERIAL	ABS
COLOR	LIGHT GRAY / BLACK
PACKAGING	50 PCS/BOX



DM-020

DM-020

TWO SCREW
58 x 106 x 32 mm

WALL MOUNT ENCLOSURE

DM-020-A

FOR SCREW

MATERIAL	ABS
COLOR	LIGHT GRAY / BLACK
PACKAGING	20 PCS/BOX



DM-022

120 x 60 x 34 mm

WALL MOUNT ENCLOSURE

MATERIAL	ABS
COLOR	LIGHT GRAY / BLACK
PACKAGING	20 PCS/BOX



DM-010

86 x 155 x 49 mm

WALL MOUNT ENCLOSURE

MATERIAL	ABS
COLOR	LIGHT GRAY / BLACK
PACKAGING	10 PCS/BOX



DM-040

116 x 60 x 19 mm

WALL MOUNT ENCLOSURE

MATERIAL	ABS
COLOR	DARK GRAY
PACKAGING	20 PCS/BOX



DM-042

90 x 74 x 22,7 mm

WALL MOUNT ENCLOSURE

MATERIAL	ABS
COLOR	LIGHT GRAY / BLACK
PACKAGING	10 PCS/BOX



DM-044

138 x 63,5 x 31 mm

WALL MOUNT ENCLOSURE

MATERIAL	ABS
COLOR	LIGHT GRAY / BLACK
PACKAGING	10 PCS/BOX



DM-045

109 x 76 x 36 mm

WALL MOUNT ENCLOSURE

MATERIAL	ABS
COLOR	LIGHT GRAY / BLACK
PACKAGING	20 PCS/BOX



DM-046

125,5 x 116 x 33 mm

WALL MOUNT ENCLOSURE

MATERIAL	ABS
COLOR	LIGHT GRAY / BLACK
PACKAGING	10 PCS/BOX



DM-048

110 x 76 x 27 mm

WALL MOUNT ENCLOSURE

MATERIAL	ABS
COLOR	WHITE / BLACK
PACKAGING	20 PCS/BOX

• SNAP FIT CLICK ASSEMBLY



DM-049

150 x 130 x 27 mm

WALL MOUNT ENCLOSURE

MATERIAL	ABS
COLOR	BLACK / WHITE
PACKAGING	20 PCS/BOX



DM-050

116 x 96 x 65 mm

WALL MOUNT ENCLOSURE

DM-050-K

W/O TERMINAL HOLE

DM-050-A

W/ TERMINAL HOLE

MATERIAL	ABS
COLOR	LIGHT GRAY / BLACK
PACKAGING	20 PCS/BOX



DM-080

DM-080

145 x 85 x 39 mm

WALL MOUNT ENCLOSURE

MATERIAL	ABS
COLOR	LIGHT GRAY / BLACK
PACKAGING	10 PCS/BOX



DM-090

DM-090

185 x 89 x 58 mm

WALL MOUNT ENCLOSURE

DM-090-A

W/ TERMINAL HOLE

DM-090-K

W/O TERMINAL HOLE

MATERIAL	ABS
COLOR	LIGHT GRAY / BLACK
PACKAGING	10 PCS/BOX



DM-100

DM-100

191 x 120 x 65 mm

WALL MOUNT ENCLOSURE

DM-100-A

W/ TERMINAL HOLE

DM-100-K

W/O TERMINAL HOLE

MATERIAL	ABS
COLOR	LIGHT GRAY / BLACK
PACKAGING	20 PCS/BOX

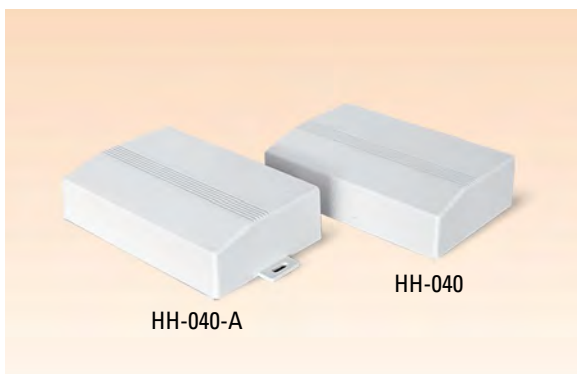

HH-040-A

HH-040

HH-040

STANDARD
175 x 115 x 44 mm

WALL MOUNT ENCLOSURE

HH-040-A

WALL MOUNT

MATERIAL	ABS
COLOR	LIGHT GRAY / BLACK
PACKAGING	10 PCS/BOX

NEW



WORK MACHINE CONTROL ENCLOSURE



VK-200

VK-200

314 x 221 x 176 mm

WORK MACHINE CONTROL ENCLOSURE

MATERIAL	ABS
COLOR	SIGNAL YELLOW RAL 1003
PACKAGING	1 PCS/BOX

- Ideal for control of small work machines.



PLUG CASES



AD-120

AD-120

152 x 59 x 29 mm

PLUG CASES

AD-120-A

PLUG: FRENCH/GERMAN VERSION ACC. TO DIN 49441 R2
SOCKET: FRENCH/GERMAN VERSION ACC. TO DIN 49440

AD-120-B

PLUG: FRENCH/GERMAN VERSION ACC. TO DIN 49441 R2
SOCKET: NONE

MATERIAL ABS - UL94 - V0
COLOR LIGHT GRAY
PACKAGING 10 PCS/BOX



AD-140-B

AD-140-A

AD-140-C

AD-140-D

AD-140

150 x 95 x 41 mm

PLUG CASES

AD-140-A

PLUG: EURO PLUG ACC. TO DIN VDE 0620 PART 11
SOCKET: NONE

AD-140-B

PLUG: FRENCH/GERMAN VERSION ACC. TO DIN 49441 R2
SOCKET: NONE

AD-140-C

PLUG: NONE
SOCKET: NONE

AD-140-D

PLUG: FRENCH/GERMAN VERSION ACC. TO DIN 49441 R2
SOCKET: FRENCH/GERMAN VERSION ACC. TO DIN 49440

MATERIAL ABS - UL94 - V0
COLOR LIGHT GRAY
PACKAGING 10 PCS/BOX



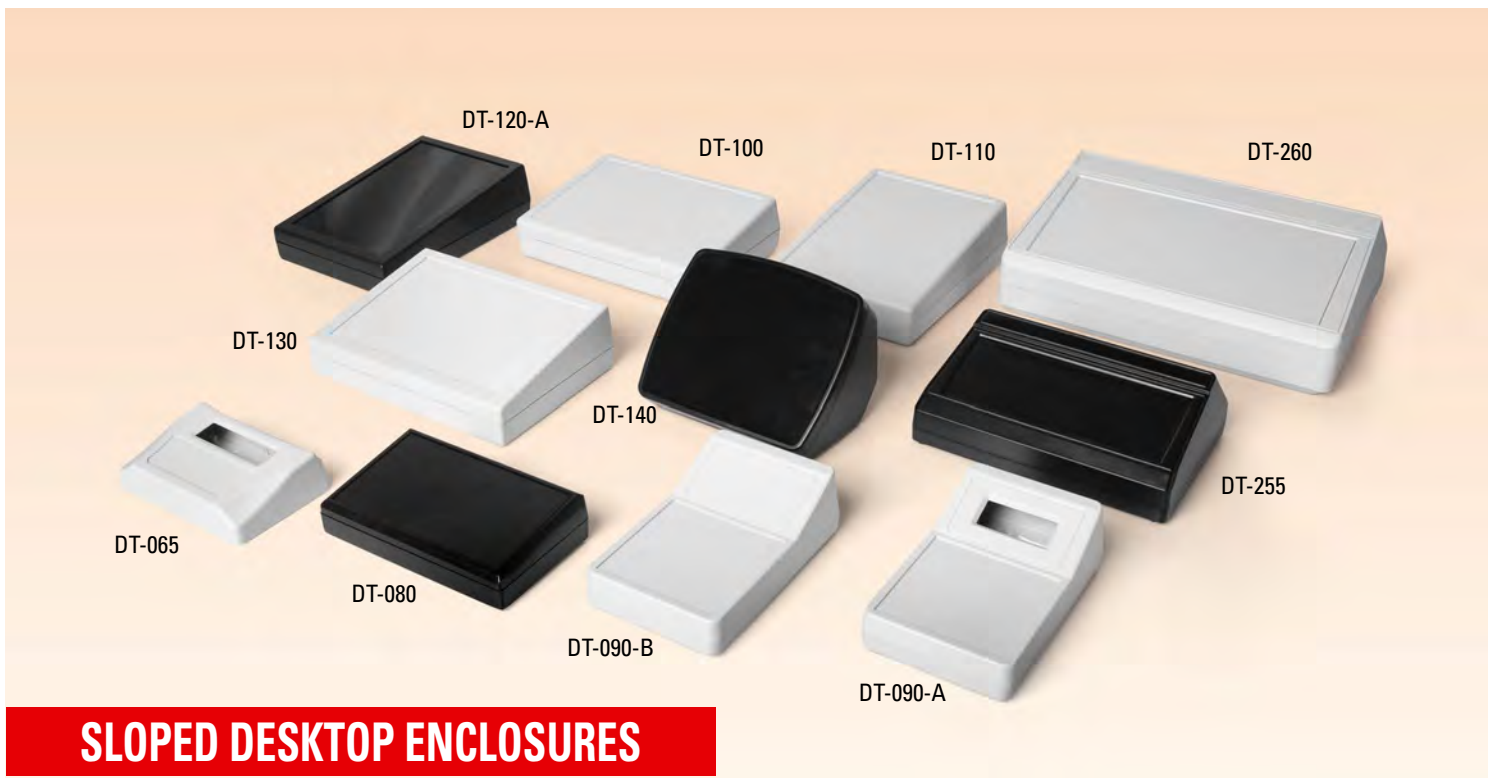

SLOPED DESKTOP ENCLOSURES



DT-065 120 x 80 x 31 mm

MATERIAL	ABS
COLOR	LIGHT GRAY / BLACK
PACKAGING	10 PCS/BOX

• WINDOW FOR 2x16 LCD SCREEN

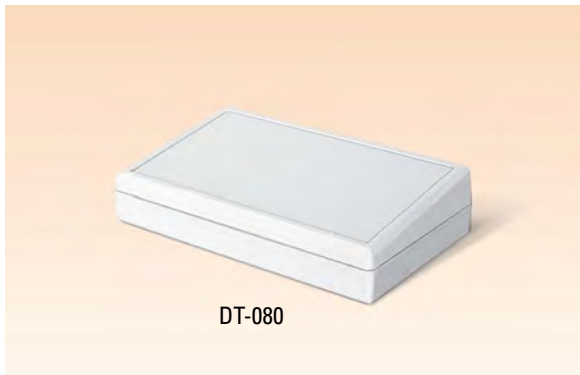

DT-080 148 x 87 x 38 mm **SLOPED DESKTOP ENCLOSURE**

MATERIAL	ABS
COLOR	LIGHT GRAY / BLACK
PACKAGING	10 PCS/BOX

SUITABLE ACCESSORIES

A-58 CLICK WALL MOUNT
A-59 WALL MOUNT EAR

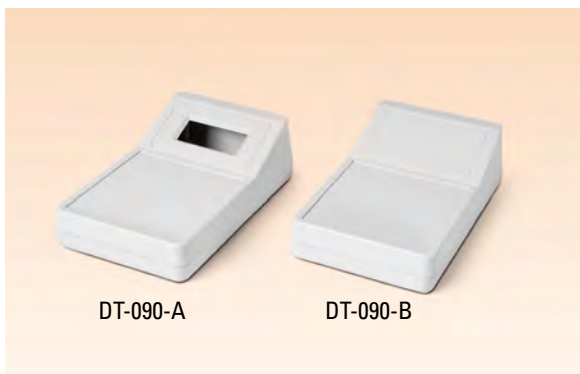

DT-090 150 x 95 x 49,5 mm **SLOPED DESKTOP ENCLOSURE**

DT-090-A	OPEN LCD PANEL
DT-090-B	CLOSED LCD PANEL
DT-090-C	FOR 2x16 LCD SCREEN
MATERIAL	ABS
COLOR	LIGHT GRAY
PACKAGING	10 PCS/BOX

SUITABLE ACCESSORIES

A-58 CLICK WALL MOUNT

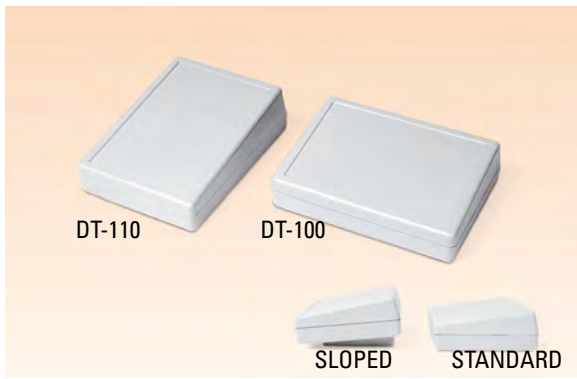

DT-100	190 x 137 x 59 mm	SLOPED DESKTOP ENCLOSURE	
DT-110	137 x 190 x 59 mm	MATERIAL	ABS
		COLOR	LIGHT GRAY / BLACK
DT-100-A	W/ SLOPED BASE	PACKAGING	10 PCS/BOX
DT-110-A	W/ SLOPED BASE	SUITABLE ACCESSORIES	
		A-58 CLICK WALL MOUNT	

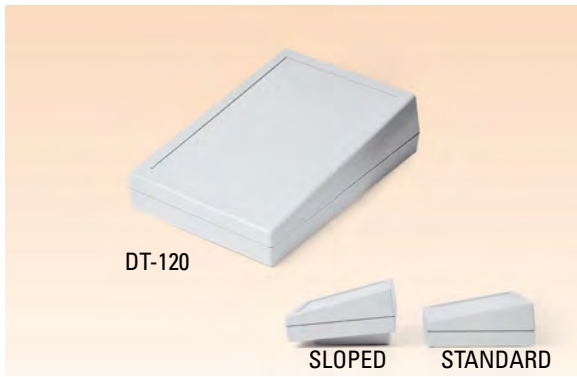

DT-120	STANDARD 133 x 188 x 55 mm	SLOPED DESKTOP ENCLOSURE	
DT-120-A	W/ SLOPED BASE	SUITABLE ACCESSORIES	
		A-58 CLICK WALL MOUNT	
	MATERIAL	ABS	
	COLOR	LIGHT GRAY / BLACK	
	PACKAGING	10 PCS/BOX	

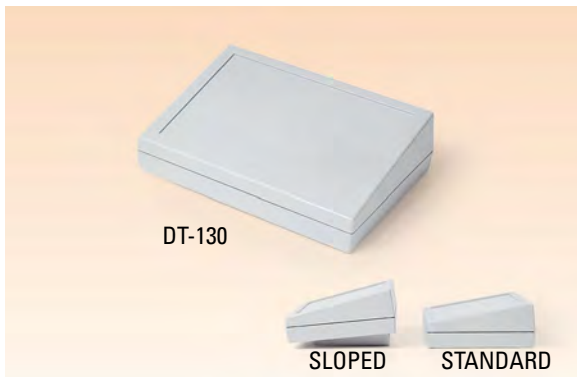

DT-130	STANDARD 188 x 133 x 55 mm	SLOPED DESKTOP ENCLOSURE	
DT-130-A	W/ SLOPED BASE	SUITABLE ACCESSORIES	
		A-58 CLICK WALL MOUNT	
	MATERIAL	ABS	
	COLOR	LIGHT GRAY / BLACK	
	PACKAGING	10 PCS/BOX	



DT-140	STANDARD 150 x 125 x 72 mm	SLOPED DESKTOP ENCLOSURE	
DT-140-A	W/BATTERY HOLDER	SUITABLE ACCESSORIES	
		A-58 CLICK WALL MOUNT	
		A-932 2xAA BATTERY CONTACT SET	
	MATERIAL	ABS	
	COLOR	LIGHT GRAY / BLACK	
	BATTERY HOLDER	2xAA & 9V APPLICABLE	
	PACKAGING	10 PCS/BOX	



DT-255	188 x 133 x 62 mm	SLOPED DESKTOP ENCLOSURE	
	MATERIAL	ABS	
	COLOR	LIGHT GRAY / BLACK	
	PACKAGING	10 PCS/BOX	
		SUITABLE ACCESSORIES	
		A-58 CLICK WALL MOUNT	



DT-260 273 x 200 x 90 mm **SLOPED DESKTOP ENCLOSURE**

MATERIAL	ABS
COLOR	LIGHT GRAY / BLACK
PACKAGING	5 PCS/BOX

SUITABLE ACCESSORIES

A-58 CLICK WALL MOUNT

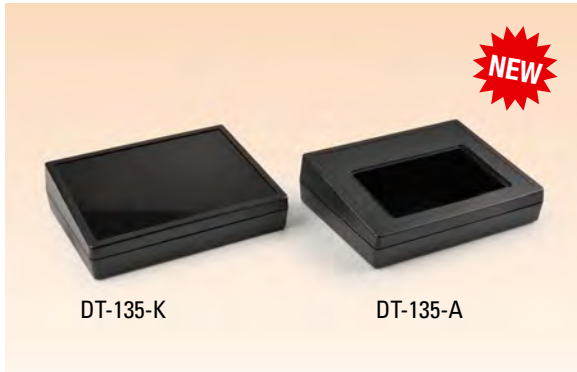

DT-135 270 x 200 x 71 mm **SLOPED DESKTOP ENCLOSURE**

DT-135-A LCD Hole For Rapsberry Pi 7" touch screen

DT-135-K CLOSED LCD PANEL

SUITABLE ACCESSORIES

A-58 CLICK WALL MOUNT

MATERIAL	ABS
COLOR	LIGHT GRAY / BLACK
PACKAGING	5 PCS/BOX

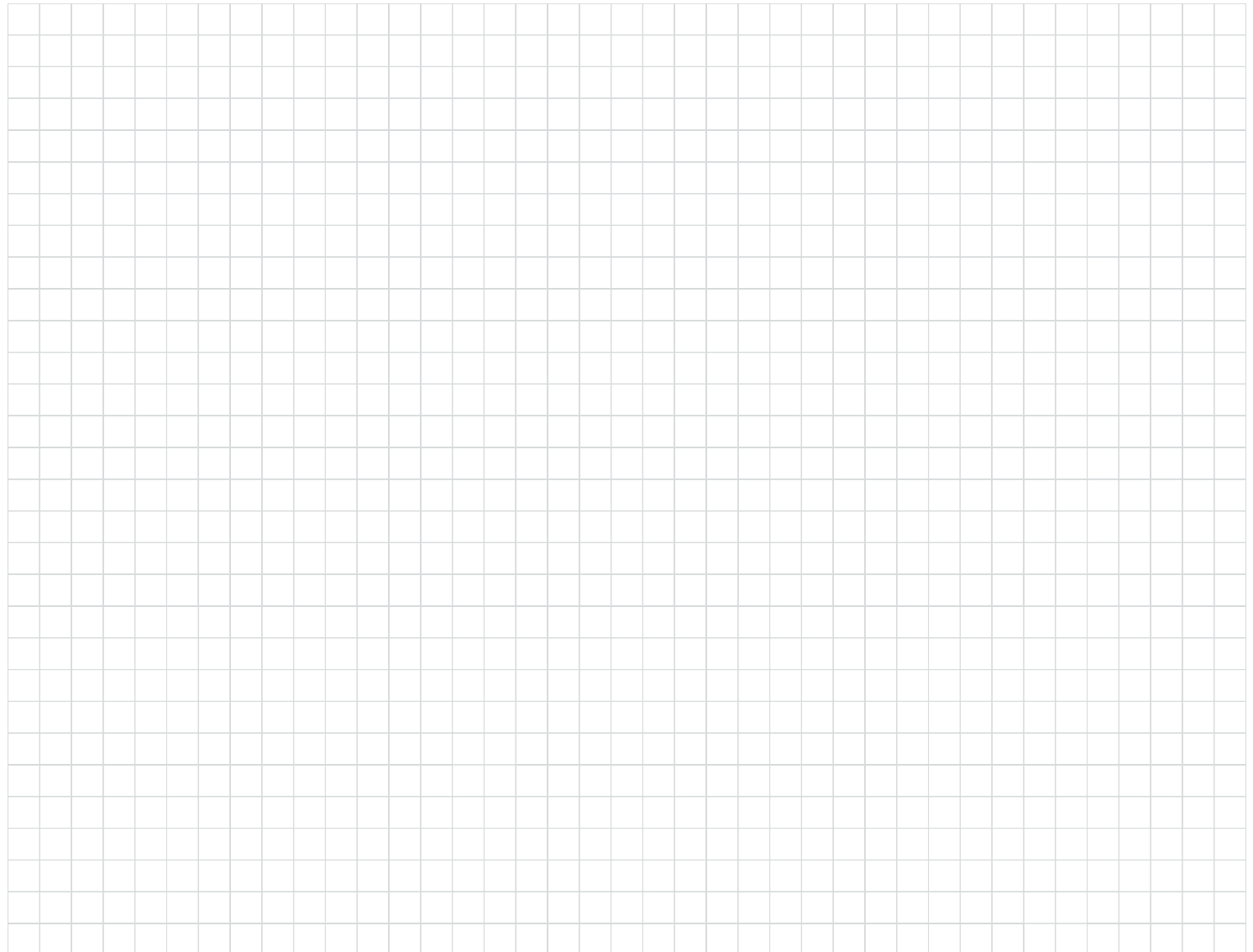

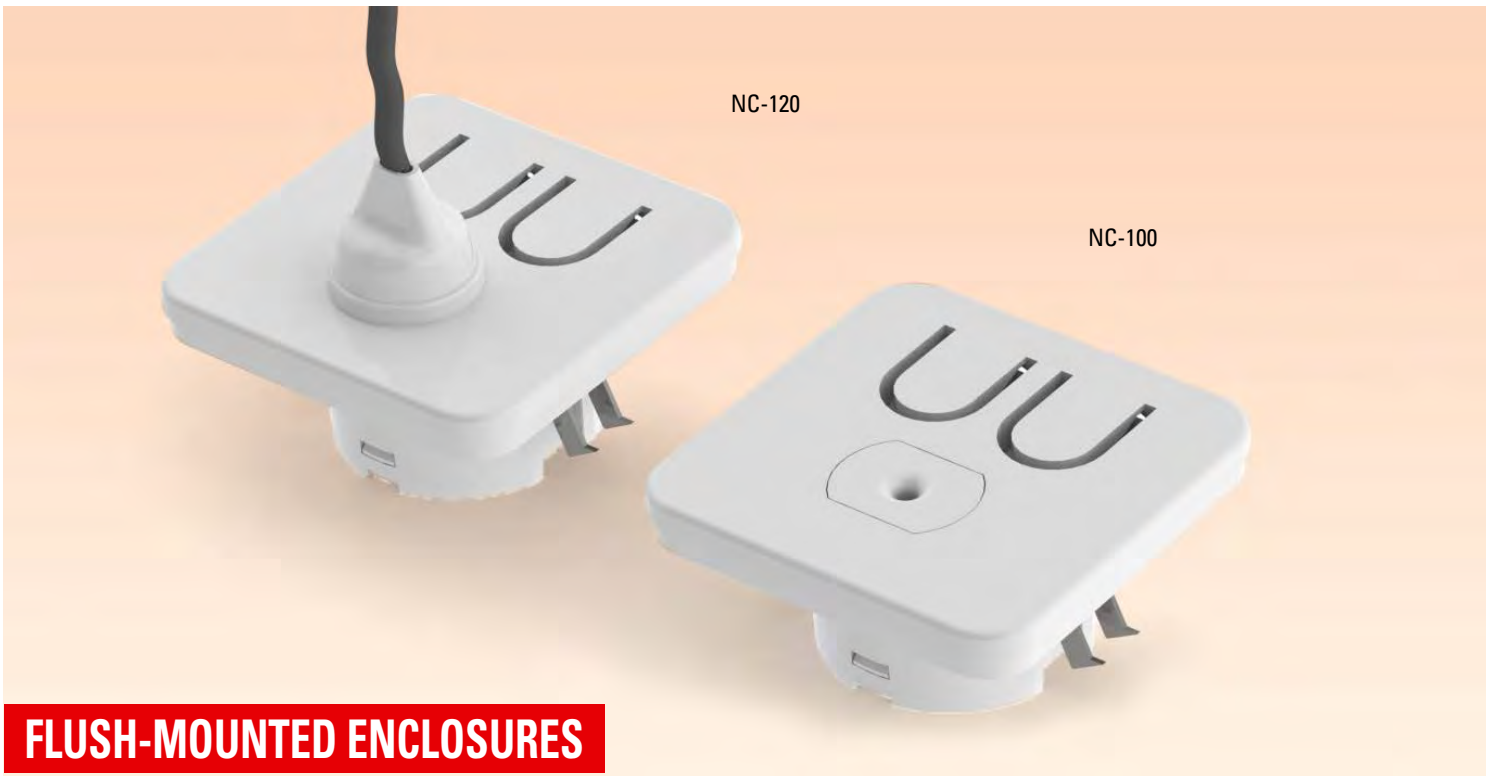

FLUSH-MOUNTED ENCLOSURES

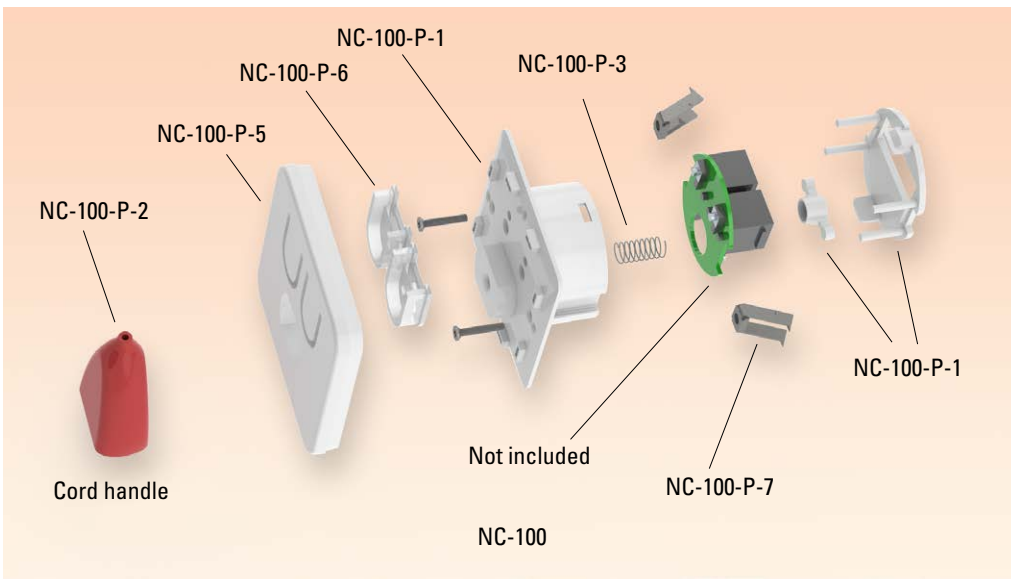

NC-100 Wc Pull Cord Enclosure
FLUSH MOUNTED EMERGENCY PULL CORD STATION ENCLOSURE

MATERIAL	ABS
COLOR	WHITE
PACKAGING	10 PCS/BOX

- COMPATIBLE WITH 60 MM CIRCULAR WALL BOX
- FOR NURSE CALLING AND WC EMERGENCY
- ELECTRONIC CIRCUIT NOT INCLUDED

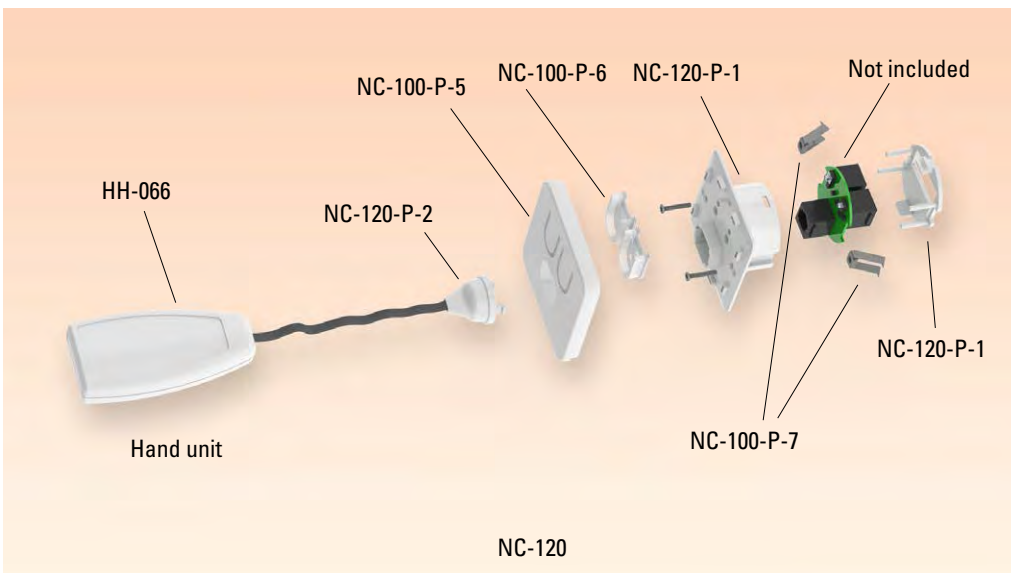

NC-120 Bed Unit Enclosure
FLUSH MOUNTED EMERGENCY CALL STATION ENCLOSURE

MATERIAL	ABS
COLOR	WHITE
PACKAGING	10 PCS/BOX

- COMPATIBLE WITH 60 MM CIRCULAR WALL BOX
- USED IN NURSE CALLING SYSTEMS
- HAND UNIT SOLD SEPERATELY
- ELECTRONIC CIRCUIT NOT INCLUDED

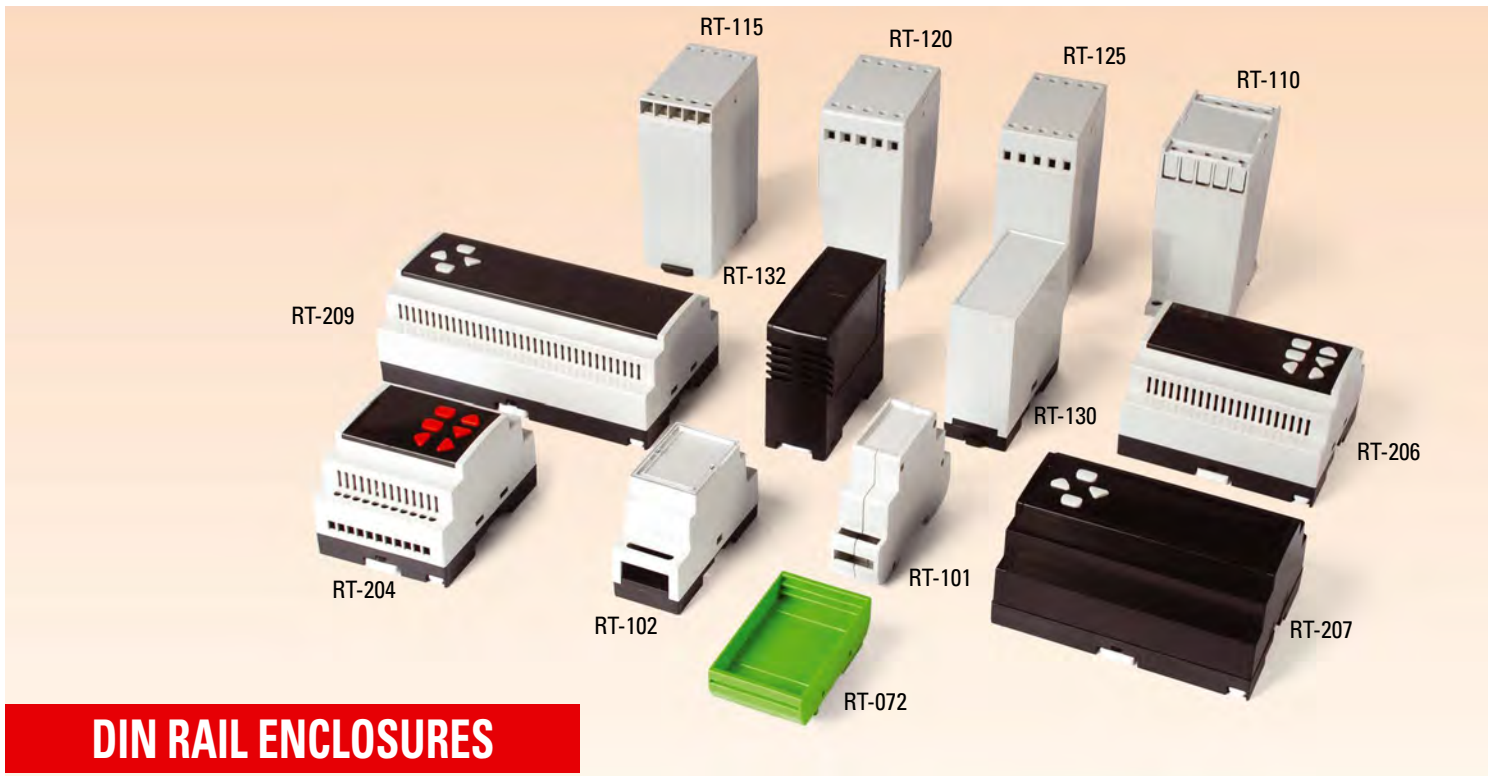

DIN RAIL ENCLOSURES

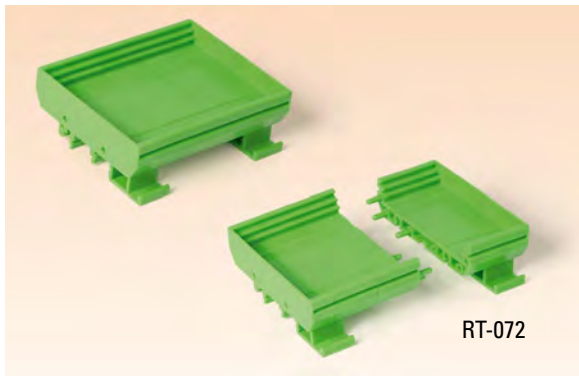

RT-072	CARD CRADLE 72 mm EN	DIN RAIL ENCLOSURE	
RT-072-1	SIDE CAP	MATERIAL	PA
		COLOR	GREEN
RT-072-2	CARD CRADLE EXTENSION	CARD WIDTH	72 mm or 68 mm
		CARD LENGTH	21 mm + 22,6 x EXTENSION
RT-072-3	CARD CRADLE DIN HOLDER		

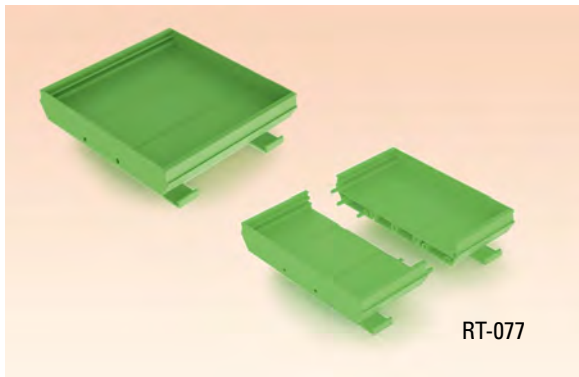

RT-077	CARD CRADLE 107 mm width	DIN RAIL ENCLOSURE	
RT-077-1	SIDE CAP	MATERIAL	PA
		COLOR	GREEN
RT-077-2	EXTENSION (17,5 mm)	CARD WIDTH	107mm
RT-077-3	EXTENSION (35 mm)		
RT-077-4	CARD CRADLE DIN HOLDER		

RT-025 DIN RAY MOUNT CARD CRADLE (RAY DISTANCE)

RT-025	MATERIAL	PA
	COLOR	GREEN

RT-075 WALL MOUNTING KIT (SHORT)

RT-075	MATERIAL	PA
	COLOR	GREEN

RT-076 WALL MOUNTING KIT (LONG)

RT-076	MATERIAL	PA
	COLOR	GREEN



RT-101

90 x 67 x 25 mm

DIN RAIL ENCLOSURE

MATERIAL	ABS
COLOR	LIGHT GRAY
PACKAGING	50 PCS/BOX

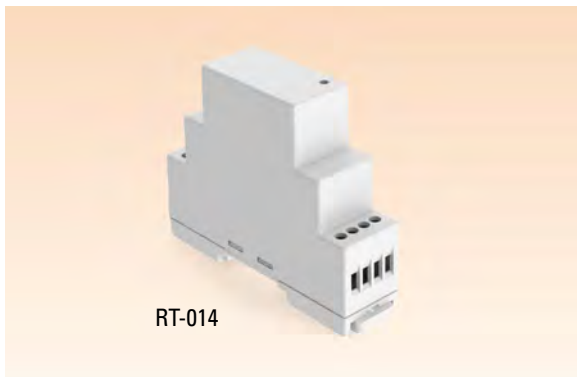

RT-014

90 x 25 x 73 mm

DIN RAIL ENCLOSURE

MATERIAL	ABS
COLOR	LIGHT GRAY
PACKAGING	20 PCS/BOX

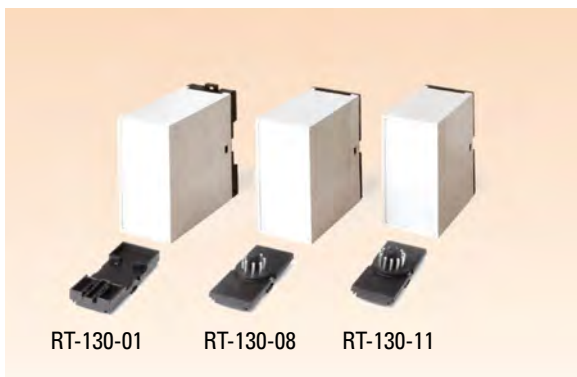

RT-130

STANDARD
36 x 86 x 77 mm

DIN RAIL ENCLOSURE

RT-130-08

8 PINS SOCKET TYPE

RT-130-11

11 PINS SOCKET TYPE

MATERIAL	ABS
COLOR	LIGHT GRAY - BLACK
PACKAGING	20 PCS/BOX



RT-132

36 x 86 x 77 mm

DIN RAIL ENCLOSURE

MATERIAL	ABS
COLOR	BLACK
PANEL	SMOKED / BLACK
PACKAGING	20 PCS/BOX



RT-110

50 x 75 x 110 mm

DIN RAIL ENCLOSURE

MATERIAL	ABS
COLOR	LIGHT GRAY / BLACK
PACKAGING	50 PCS/BOX

SUITABLE ACCESSORIES

A-140 TERMINAL



RT-115

45 x 78 x 110 mm

DIN RAIL ENCLOSURE

MATERIAL	ABS
COLOR	LIGHT GRAY
PACKAGING	50 PCS/BOX

SUITABLE ACCESSORIES
A-144 TERMINAL



RT-120

50 x 75 x 110 mm

DIN RAIL ENCLOSURE

MATERIAL	ABS
COLOR	LIGHT GRAY
PACKAGING	50 PCS/BOX

SUITABLE ACCESSORIES
A-142 TERMINAL
A-143 TERMINAL CAP



RT-125

45 x 78 x 110 mm

DIN RAIL ENCLOSURE

MATERIAL	ABS
COLOR	LIGHT GRAY
PACKAGING	50 PCS/BOX

SUITABLE ACCESSORIES
A-146 TERMINAL
A-147 TERMINAL CAP

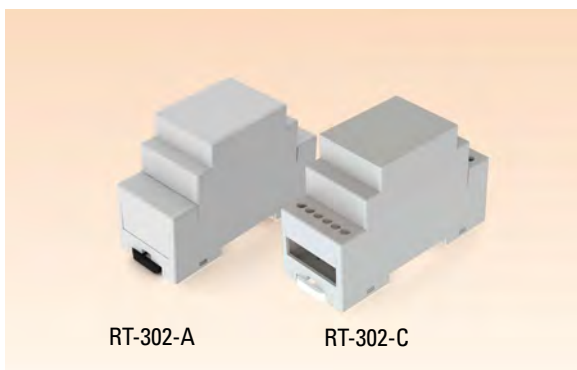

RT-302

36,7 x 90,3 x 60 mm

DIN RAIL ENCLOSURE

RT-302-A

FULLY CLOSED

MATERIAL	ABS
COLOR	LIGHT GRAY

RT-302-C

FOR SCREW
TERMINAL

PANEL	LIGHT GRAY
PACKAGING	20 PCS/BOX

RT-302-E

FOR SOCKET
TERMINAL



RT-409

157,5 x 90 x 43 mm

DIN RAIL ENCLOSURE

MATERIAL	ABS
COLOR	BLACK / LIGHT GRAY
PACKAGING	20 PCS/BOX

 <p>RT-202-A RT-202-B RT-202-C</p>	RT-202	35 x 86 x 59 mm	DIN RAIL ENCLOSURE	
	RT-202-A	FULLY CLOSED	MATERIAL	ABS
	RT-202-B	W/ VENTILATION	COLOR	LIGHT GRAY
	RT-202-C	FOR SCREW TERMINAL	PANEL	CLEAR/ SMOKED/ LIGHT GRAY
	RT-202-D	BREAKABLE FOR SOCKET TERMINAL	PACKAGING	20 PCS/BOX

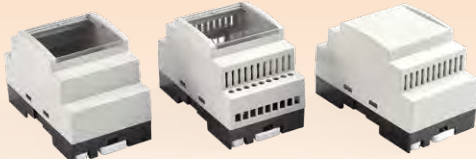
 <p>RT - 203-A RT-203-C RT-203-B</p>	RT-203	52,5 x 90 x 59 mm	DIN RAIL ENCLOSURE	
	RT-203-A	FULLY CLOSED	MATERIAL	ABS
	RT-203-B	W/ VENTILATION	COLOR	LIGHT GRAY
	RT-203-C	FOR SCREW TERMINAL	PANEL	CLEAR/ SMOKED/ LIGHT GRAY
	RT-203-D	BREAKABLE FOR SOCKET TERMINAL	PACKAGING	20 PCS/BOX

 <p>RT-204</p>	RT-204	70 x 91 x 58,4 mm	DIN RAIL ENCLOSURE	
	RT-204-A	FULLY CLOSED	MATERIAL	ABS
	RT-204-B	W/ VENTILATION	COLOR	LIGHT GRAY
	RT-204-C	FOR SCREW TERMINAL	PANEL	CLEAR/ SMOKED/ LIGHT GRAY
	RT-204-D	BREAKABLE FOR SOCKET TERMINAL	PACKAGING	20 PCS/BOX

 <p>RT-206</p>	RT-206	105 x 91 x 58,4 mm	DIN RAIL ENCLOSURE	
	RT-206-A	FULLY CLOSED	MATERIAL	ABS
	RT-206-B	W/ VENTILATION	COLOR	LIGHT GRAY
	RT-206-C	FOR SCREW TERMINAL	PANEL	CLEAR/ SMOKED/ LIGHT GRAY
	RT-206-D	BREAKABLE FOR SOCKET TERMINAL	PACKAGING	20 PCS/BOX

 <p>RT-207</p>	RT-207	122,5 x 91 x 58,4 mm	DIN RAIL ENCLOSURE	
	RT-207-A	FULLY CLOSED	MATERIAL	ABS
	RT-207-B	W/ VENTILATION	PANEL	CLEAR/ SMOKED/ LIGHT GRAY
	RT-207-C	FOR SCREW TERMINAL	COLOR	LIGHT GRAY /BLACK/ DARK GRAY
	RT-207-D	BREAKABLE FOR SOCKET TERMINAL	PACKAGING	20 PCS/BOX
			OLD CODE	RT-107

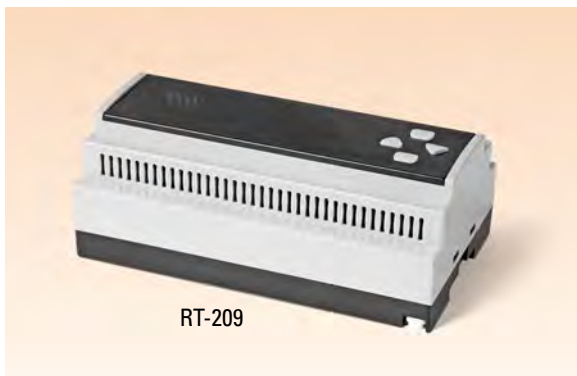

RT-209	157,5 x 91 x 58,4 mm	DIN RAIL ENCLOSURE	
RT-209-A	FULLY CLOSED	MATERIAL	ABS
RT-209-B	W/ VENTILATION	PANEL	CLEAR/ SMOKED / LIGHT GRAY
RT-209-C	FOR SCREW TERMINAL	COLOR	LIGHT GRAY
RT-209D	BREAKABLE FOR SOCKET TERMINAL	PACKAGING	20 PCS/BOX

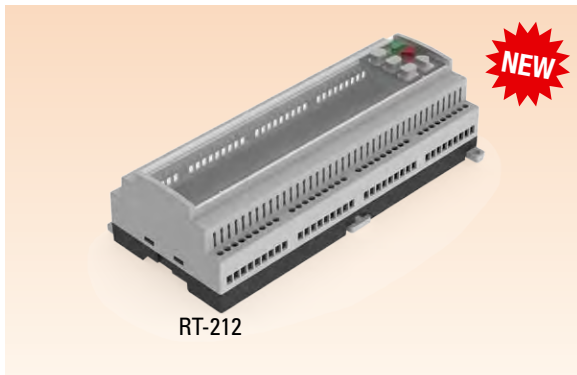

RT-212	212 x 90 x 59 mm	DIN RAIL ENCLOSURE	
RT-212-A	FULLY CLOSED	MATERIAL	ABS
RT-212-B	W/ VENTILATION	PANEL	CLEAR/ SMOKED / LIGHT GRAY
RT-212-C	FOR SCREW TERMINAL	COLOR	LIGHT GRAY
RT-212-D	BREAKABLE FOR SOCKET TERMINAL	PACKAGING	20 PCS/BOX



RT-506	105 x 90 x 45 mm	DIN RAIL ENCLOSURE	
MATERIAL	ABS		
COLOR	LIGHT GRAY		
PANEL	CLEAR/ SMOKED / LIGHT GRAY		
PACKAGING	20 PCS/BOX		



RT-152	35 x 102 x 117 mm	DIN RAIL ENCLOSURE	
RT-152-A	W TERMINAL HOLE	MATERIAL	ABS
RT-152-K	W/O TERMINAL HOLE	COLOR	LIGHT GRAY / BLACK
		PACKAGING	20 PCS/BOX



DIN PANEL ENCLOSURES NEW SERIES



PT-125

PT-125

36 x 72 x 85 mm

DIN PANEL ENCLOSURE

MATERIAL	ABS
COLOR	LIGHT GRAY / DARK GRAY / BLACK
PACKAGING	20 PCS/BOX

FRONT PANEL OPTIONS

CLEAR/ SMOKED

• ORIENTATION OF FRONT PANEL BUTTONS CAN BE CUSTOMIZED

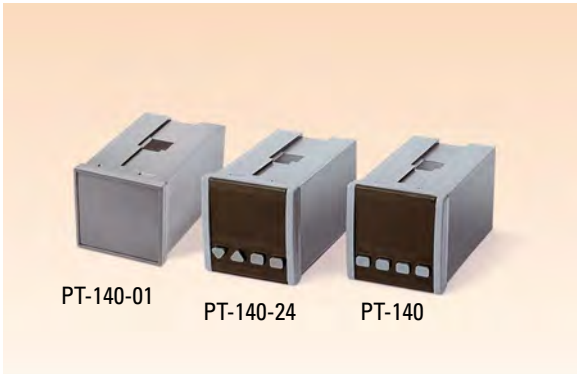

PT-140-01

PT-140-24

PT-140

PT-140-01

48 x 48 x 82 mm

DIN PANEL ENCLOSURE

PT-140-24

48 x 48 x 85 mm
W/ BUTTONS

MATERIAL	ABS
COLOR	LIGHT GRAY / DARK GRAY / BLACK
PACKAGING	20 PCS/BOX

FRONT PANEL OPTIONS

OPAQUE/ SMOKED / CLEAR

• ORIENTATION OF FRONT PANEL BUTTONS CAN BE CUSTOMIZED



PT-165

PT-165

48 x 96 x 77 mm

DIN PANEL ENCLOSURE

MATERIAL	ABS
COLOR	LIGHT GRAY / BLACK
PACKAGING	20 PCS/BOX

FRONT PANEL OPTIONS

OPAQUE/ SMOKED / CLEAR

• ORIENTATION OF FRONT PANEL BUTTONS CAN BE CUSTOMIZED



PT-190-01

PT-190-24

PT-190-01

72 x 72 x 81 mm

DIN PANEL ENCLOSURE

PT-190-24

72 x 72 x 85 mm
W/ BUTTONS

MATERIAL ABS
COLOR LIGHT GRAY / DARK GRAY / BLACK
PACKAGING 20 PCS/BOX

FRONT PANEL OPTIONS

OPAQUE/ SMOKED / CLEAR

• ORIENTATION OF FRONT PANEL BUTTONS CAN BE CUSTOMIZED



PT-210-24

PT-210-01

72 x 144 x 108 mm

DIN PANEL ENCLOSURE

PT-210-24

72 x 144 x 115 mm
W/ BUTTONS

MATERIAL ABS
COLOR LIGHT GRAY / DARK GRAY / BLACK
PACKAGING 20 PCS/BOX

FRONT PANEL OPTIONS

OPAQUE/ SMOKED / CLEAR

• ORIENTATION OF FRONT PANEL BUTTONS CAN BE CUSTOMIZED



PT-220-24

PT-220-01

PT-220-01

96 x 96 x 72 mm

DIN PANEL ENCLOSURE

PT-220-24

96 x 96 x 76 mm
W/ BUTTONS

MATERIAL ABS
COLOR LIGHT GRAY / DARK GRAY / BLACK
PACKAGING 20 PCS/BOX

FRONT PANEL OPTIONS

OPAQUE/ SMOKED / CLEAR

• ORIENTATION OF FRONT PANEL BUTTONS CAN BE CUSTOMIZED



PT-100-A

PT-100-B

PT-100-A

ALL OPEN
33 x 75 x 79 mm

DIN PANEL ENCLOSURE

PT-100-B

W/ STICKER PANEL
33 x 75 x 79 mm

MATERIAL ABS
COLOR BLACK
PACKAGING 20 PCS/BOX

FRONT PANEL OPTIONS

LIGHT GRAY / CLEAR/ RED



PT-102



PT-102

76,5 x 34,5 x 70 mm

DIN PANEL ENCLOSURE

MATERIAL BODY ABS V0 / PANEL PC
COLOR BLACK
PACKAGING 20 PCS / BOX



PT-110

PT-110

37 x 63 x 61 mm

DIN PANEL ENCLOSURE

MATERIAL	ABS
COLOR	LIGHT GRAY / BLACK
PACKAGING	40 PCS/BOX

FRONT PANEL OPTIONS

RED / GRAY



PT-112

PT-112

37 x 62 x 61 mm

DIN PANEL ENCLOSURE

MATERIAL	ABS
COLOR	LIGHT GRAY / BLACK
PACKAGING	40 PCS/BOX

FRONT PANEL OPTIONS

RED / GRAY

NO SCREW CLICK ASSEMBLY

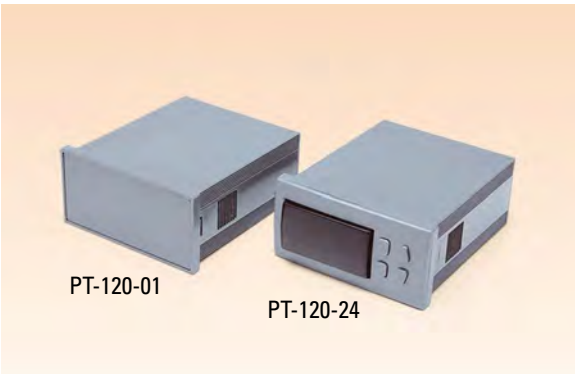

PT-120-01

PT-120-24

PT-120-01

36 x 72 x 81 mm

DIN PANEL ENCLOSURE

PT-120-24

W/ BUTTONS
36 x 72 x 85 mm

CONCAVE FRONT PANEL COLOR OPTIONS

SMOKED / RED

MATERIAL	ABS
COLOR	LIGHT GRAY / DARK GRAY / BLACK
PACKAGING	20 PCS/BOX

FRONT PANEL OPTIONS

OPAQUE/ CLEAR/ RED



PT-130

PT-130

36 x 72 x 85 mm

DIN PANEL ENCLOSURE

MATERIAL	ABS
COLOR	LIGHT GRAY / BLACK
PACKAGING	20 PCS/BOX



PT-150

PT-150

48 x 48 x 87 mm

DIN PANEL ENCLOSURE

MATERIAL	ABS
COLOR	LIGHT GRAY / BLACK
PACKAGING	20 PCS/BOX

CONNECTION OPTIONS

8 PINS SOCKET TYPE

11 PINS SOCKET TYPE

FRONT PANEL OPTIONS

LIGHT GRAY / CLEAR/ RED



PT-160

PT-160

48 x 96 x 123 mm

DIN PANEL ENCLOSURE

MATERIAL	ABS
COLOR	LIGHT GRAY / BLACK
PACKAGING	20 PCS/BOX

FRONT PANEL OPTIONS

LIGHT GRAY / CLEAR / RED



PT-170

PT-170

72 x 72 x 74 mm

DIN PANEL ENCLOSURE

MATERIAL	ABS
COLOR	LIGHT GRAY / BLACK
PACKAGING	40 PCS/BOX

BACK PANEL OPTIONS

FLAT PANEL
TERMINAL PANEL



PT-180

PT-180

72 x 72 x 75 mm

DIN PANEL ENCLOSURE

MATERIAL	ABS
COLOR	LIGHT GRAY / BLACK
PACKAGING	20 PCS/BOX

FRONT PANEL COLOR OPTIONS

LIGHT GRAY / CLEAR / RED

BACK PANEL OPTIONS

FLAT PANEL
TERMINAL PANEL



PT-200

PT-200

72 x 72 x 104 mm

DIN PANEL ENCLOSURE

MATERIAL	ABS
COLOR	LIGHT GRAY / BLACK
PACKAGING	20 PCS/BOX

FRONT PANEL COLOR OPTIONS

LIGHT GRAY / CLEAR / RED

BACK PANEL OPTIONS

FLAT PANEL
TERMINAL PANEL



PT-212

PT-212

72 x 144 x 162 mm

DIN PANEL ENCLOSURE

MATERIAL	ABS
COLOR	LIGHT GRAY / BLACK
PACKAGING	20 PCS/BOX

FRONT PANEL COLOR OPTIONS

LIGHT GRAY / CLEAR / RED

*PROTECTIVE CLEAR CAP IS OPTIONAL



PT-230

PT-230

96 x 96 x 74 mm

DIN PANEL ENCLOSURE

MATERIAL	ABS
COLOR	LIGHT GRAY / BLACK
PACKAGING	20 PCS/BOX

BACK PANEL OPTIONS

FLAT PANEL
TERMINAL PANEL



PT-240

PT-240

96 x 96 x 75 mm

DIN PANEL ENCLOSURE

MATERIAL	ABS
COLOR	LIGHT GRAY / BLACK
PACKAGING	20 PCS/BOX

FRONT PANEL COLOR OPTIONS

LIGHT GRAY / CLEAR / RED

BACK PANEL OPTIONS

FLAT PANEL
TERMINAL PANEL



PT-250

PT-250

96 x 96 x 102 mm

DIN PANEL ENCLOSURE

MATERIAL	ABS
COLOR	LIGHT GRAY / BLACK
PACKAGING	20 PCS/BOX

FRONT PANEL COLOR OPTIONS

LIGHT GRAY / CLEAR / RED

BACK PANEL OPTIONS

FLAT PANEL
TERMINAL PANEL



PT-260

PT-260

96 x 96 x 135 mm

DIN PANEL ENCLOSURE

MATERIAL	ABS
COLOR	LIGHT GRAY / BLACK
PACKAGING	20 PCS/BOX

FRONT PANEL COLOR OPTIONS

LIGHT GRAY / CLEAR / RED

BACK PANEL OPTIONS

FLAT PANEL
TERMINAL PANEL



PT-270

PT-270

144 x 144 x 85 mm

DIN PANEL ENCLOSURE

MATERIAL	ABS
COLOR	LIGHT GRAY / BLACK
PACKAGING	20 PCS/BOX

FRONT PANEL COLOR OPTIONS

LIGHT GRAY OPAQUE / HINGED TRANSPARENT
--

BACK PANEL OPTIONS

FLAT PANEL
TERMINAL PANEL



PT-280

144 x 144 x 140 mm

DIN PANEL ENCLOSURE

MATERIAL ABS
COLOR LIGHT GRAY/BLACK
PACKAGING 20 PCS/BOX

FRONT PANEL COLOR OPTIONS

LIGHT GRAY/MENTEŞELI CAM KAPAK

BACK PANEL OPTIONS

FLAT PANEL
TERMINAL PANEL

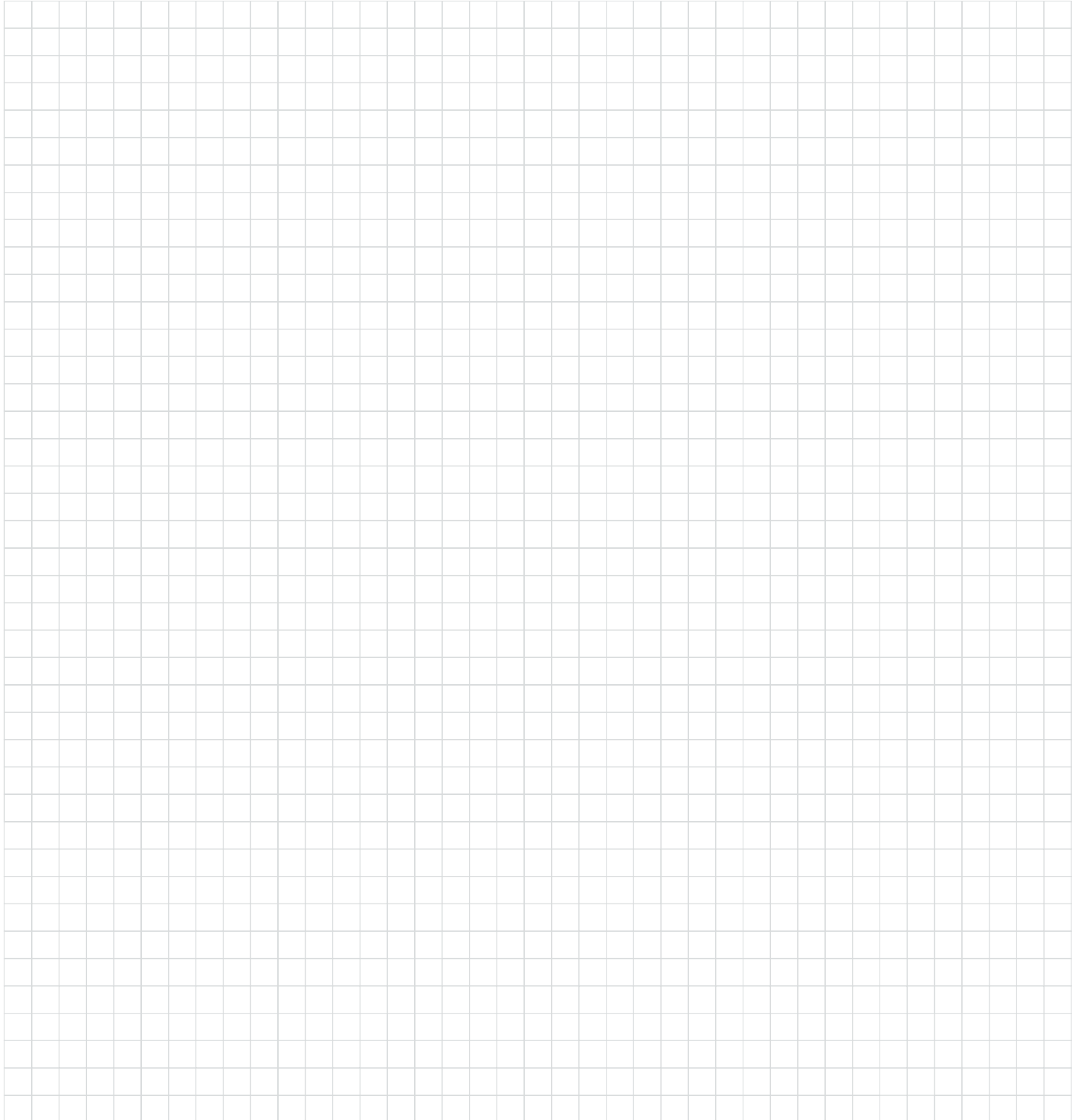



OPERATOR PANEL ENCLOSURES



OP-100-A

OPEN FRONT PANEL
233 x 130 x 83 mm

OPERATOR PANEL ENCLOSURE

OP-100-K

CLOSED FRONT PANEL

MATERIAL ABS-FR

COLOR BLACK

PACKAGING 5 PCS/BOX



OP-300

CLOSED FLAT PANEL
180 x 130 x 50 mm

OPERATOR PANEL ENCLOSURE

OP-300-A

CURVED LCD PANEL

MATERIAL ABS

COLOR DARK GRAY / BLACK / LIGHT GRAY

PACKAGING 10 PCS/BOX

OP-300-B

FLAT LCD PANEL

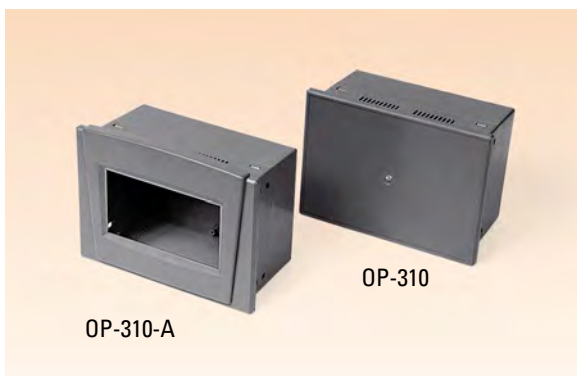

OP-310

CLOSED FLAT PANEL
180 x 130 x 89 mm

OPERATOR PANEL ENCLOSURE

OP-310-A

CURVED LCD PANEL

OP-310-B

FLAT LCD PANEL

MATERIAL ABS

COLOR DARK GRAY / BLACK / LIGHT GRAY

PACKAGING 10 PCS/BOX



PT-340

255 x 118 x 23 mm

OPERATOR PANEL ENCLOSURE

MATERIAL	ABS
COLOR	LIGHT GRAY / DARK GRAY
PACKAGING	10 PCS/BOX

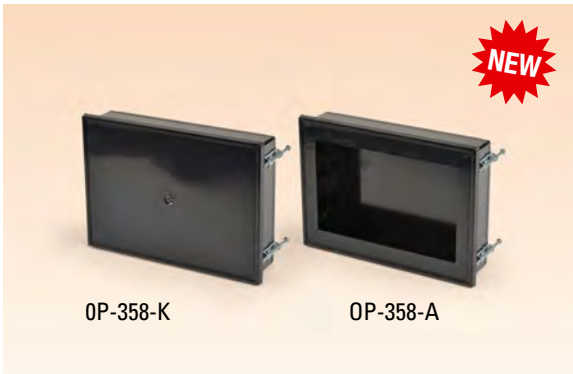

OP-358

209.6 x 146.5 x 46,5 mm

OPERATOR PANEL ENCLOSURE

OP-358-A

W/ 7" WINDOW

OP-358-K

CLOSED FRONT

MATERIAL	ABS
COLOR	DARK GRAY / BLACK / LIGHT GRAY
PACKAGING	10 PCS/BOX



OP-360

209.6 x 146.5 x 65.7 mm

OPERATOR PANEL ENCLOSURE

OP-360-A

W/ 7" WINDOW

OP-360-K

CLOSED FRONT

MATERIAL	ABS
COLOR	DARK GRAY / BLACK / LIGHT GRAY
PACKAGING	10 PCS/BOX



OP-362

209.6 x 146.5 x 92.7 mm

OPERATOR PANEL ENCLOSURE

OP-362-A

W/ 7" WINDOW

OP-362-K

CLOSED FRONT

MATERIAL	ABS
COLOR	DARK GRAY / BLACK / LIGHT GRAY
PACKAGING	1 PCS/BOX



PLASTIC PROJECT ENCLOSURES

- Low cost
- Material: ABS UL94-HB
- Vertical card slots
- Optional wall mounting ears
- TPE screw caps
- Black color

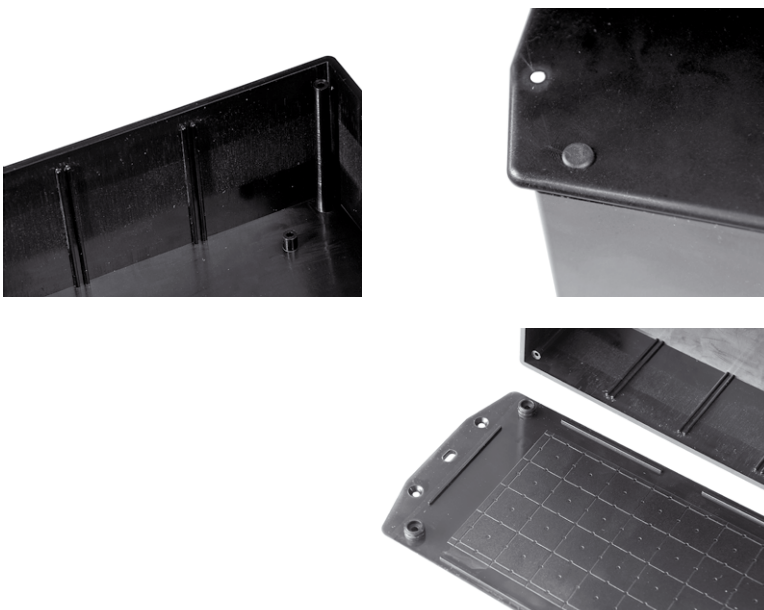
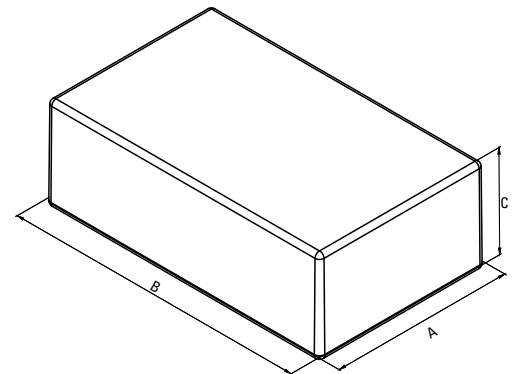

Code	Width (A)	Length (B)	Height (C)	Wall Mountable
PR-040	54	83	30	
PR-040-A	54	83	30	Yes
PR-080	60	106	45	
PR-080-A	60	106	45	Yes
PR-120	68	130	44	
PR-120-A	68	130	44	Yes
PR-224	96	158	53	
PR-224-A	96	158	53	Yes
PR-240	113	197,4	63	
PR-240-A	113	197,4	63	Yes



PLASTIC PROJECT ENCLOSURES

- Material: ABS UL94-HB
- Light gray and black color options
- Low cost
- Removable front and back panels
- Wall mountable with suitable accessories
- Special sloped mounting kit for DT-210 and DT-220

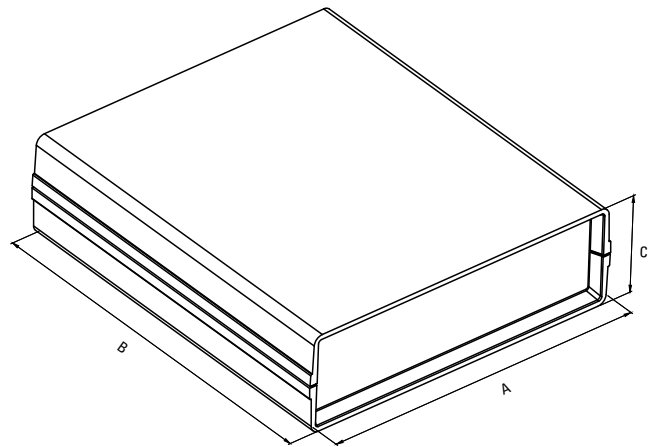

Code	Width (A)	Length (B)	Height (C)	Screws
HH-8080	85	155	30	4 PCS
HH-8082	85	155	45	4 PCS
HH-8282	85	155	60	4 PCS
DT-085	145	85	38	2 PCS
DT-0505	130	138	48	2 PCS
DT-0508	130	138	54	2 PCS
DT-0808	130	138	61	2 PCS
DT-0909	126	137	82	2 PCS
DT-1010	154	174	47	4 PCS
DT-1020	154	174	54	4 PCS
DT-2020	154	174	61	4 PCS
DT-210	166	120	45	4 PCS
Angled mounting kit DT-210-A	166	120	45	4 PCS
DT-220	226	166	60	4 PCS
Angled mounting kit DT-220-A	226	166	60	4 PCS

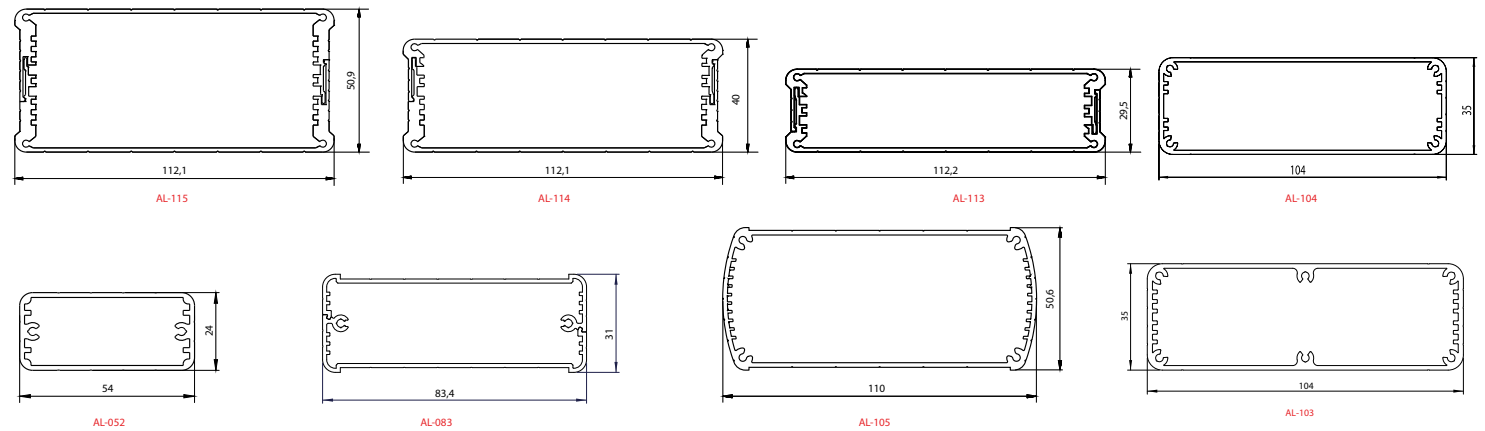

AL-052-5	54 x 24 x 56 mm	ALUMINIUM PROFILE ENCLOSURE	
AL-052-10	54 x 24 x 106 mm	MATERIAL	ALUMINIUM 6063
AL-052-15	54 x 24 x 156 mm	COLOR	BLACK (RAL 9005) / CREAM (RAL 9001) / SILVER (RAL 9006)
AL-052-20	54 x 24 x 206 mm	SURFACE	ELECTROSTATIC GLOSS
AL-052-XX	54 x 24 x (CUSTOM)	END CAPS	ALUMINIUM
		* AL-052-XX length can be customized between 40mm to 3m	



AL-083-5	83,4 x 31 x 62 mm	ALUMINIUM PROFILE ENCLOSURE	
AL-083-10	83,4 x 31 x 112 mm	MATERIAL	ALUMINIUM 6063
AL-083-15	83,4 x 31 x 162 mm	COLOR	NATURAL / BLACK
AL-083-20	83,4 x 31 x 212 mm	SURFACE	MATT ANODIZED
AL-083-XX	83,4 x 31 x (CUSTOM)	END CAPS	FLAT PLASTIC MOUNTABLE PLASTIC
		* AL-083-XX length can be customized between 40mm to 3m	



AL-103

AL-103-5	104 x 35 x 56 mm	ALUMINIUM PROFILE ENCLOSURE
AL-103-10	104 x 35 x 106 mm	MATERIAL ALUMINIUM 6063
AL-103-15	104 x 35 x 156 mm	COLOR NATURAL / BLACK
AL-103-20	104 x 35 x 206 mm	SURFACE MATT ANODIZED
AL-103-XX	104 x 35 x (CUSTOM)	END CAPS 1.5mm ALUMINIUM
* AL-103-XX length can be customized between 40mm to 3m		



AL-105

AL-105-5	110 x 50 x 56 mm	ALUMINIUM PROFILE ENCLOSURE
AL-105-10	110 x 50 x 106 mm	MATERIAL ALUMINIUM 6063
AL-105-15	110 x 50 x 156 mm	COLOR NATURAL / BLACK
AL-105-20	110 x 50 x 206 mm	SURFACE MATT ANODIZED
AL-105-XX	110 x 50 x (CUSTOM)	END CAPS 1.5mm ALUMINIUM
* AL-105-XX length can be customized between 40mm to 3m		



AL-113

AL-113-5	112 x 29.5 x 56 mm	ALUMINIUM PROFILE ENCLOSURE
AL-113-10	112 x 29.5 x 106 mm	MATERIAL ALUMINIUM 6063
AL-113-15	112 x 29.5 x 156 mm	COLOR GRAPHITE GRAY/ CREAM/ SILVER / BLACK
AL-113-20	112 x 29.5 x 206 mm	SURFACE ELECTROSTATIC GLOSS
AL-113-XX	112 x 29.5 x (CUSTOM)	END CAPS FLAT PLASTIC MOUNTABLE PLASTIC NATURAL ALUMINIUM
PLASTIC END CAPS BLACK/ DARK GRAY/ LIGHT GRAY		
* AL-113-XX length can be customized between 40mm to 3m		



AL-114

AL-114-5	112 x 40 x 56 mm	ALUMINIUM PROFILE ENCLOSURE
AL-114-10	112 x 40 x 106 mm	MATERIAL ALUMINIUM 6063
AL-114-15	112 x 40 x 156 mm	COLOR GRAPHITE GRAY/ CREAM/ SILVER / BLACK
AL-114-20	112 x 40 x 206 mm	SURFACE ELECTROSTATIC GLOSS
AL-114-XX	112 x 40 x (CUSTOM)	END CAPS FLAT PLASTIC MOUNTABLE PLASTIC NATURAL ALUMINIUM
PLASTIC END CAPS BLACK/ DARK GRAY/ LIGHT GRAY		
* AL-114-XX length can be customized between 40mm to 3m		

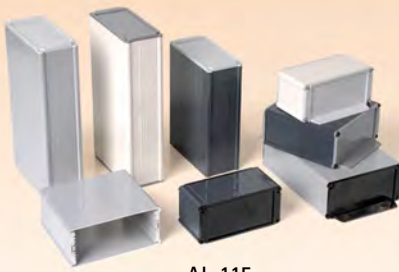

AL-115

AL-115-5	112 x 50 x 56 mm	ALUMINIUM PROFILE ENCLOSURE
AL-115-10	112 x 50 x 106 mm	MATERIAL ALUMINIUM 6063
AL-115-15	112 x 50 x 156 mm	COLOR GRAFIT GRAYS/ CREAM/ SILVER / BLACK
AL-115-20	112 x 50 x 206 mm	SURFACE ELECTROSTATIC GLOSS
AL-115-XX	112 x 50 x (CUSTOM)	END CAPS FLAT PLASTIC MOUNTABLE PLASTIC NATURAL ALUMINIUM
PLASTIC END CAPS BLACK/ DARK GRAY/ LIGHT GRAY		
* AL-115-XX length can be customized between 40mm to 3m		



METAL PROJECT ENCLOSURES

- 1,5 mm mild steel
- High quality bending with die
- Electrostatic powder coating
- Ventilation holes
- Black (RAL 9005) textured top cover

- White glossy base
- M3 assembly screws
- Plastic feet
- Mounting holes on base

Code	Width (A)	Length (B)	Height (C)
MP-050	63,5	127	51
MP-055	63,5	127	90
MP-080	127	127	51
MP-085	127	127	90
MP-120	165	127	51
MP-125	165	127	90
MP-160	229	127	51
MP-165	229	127	90

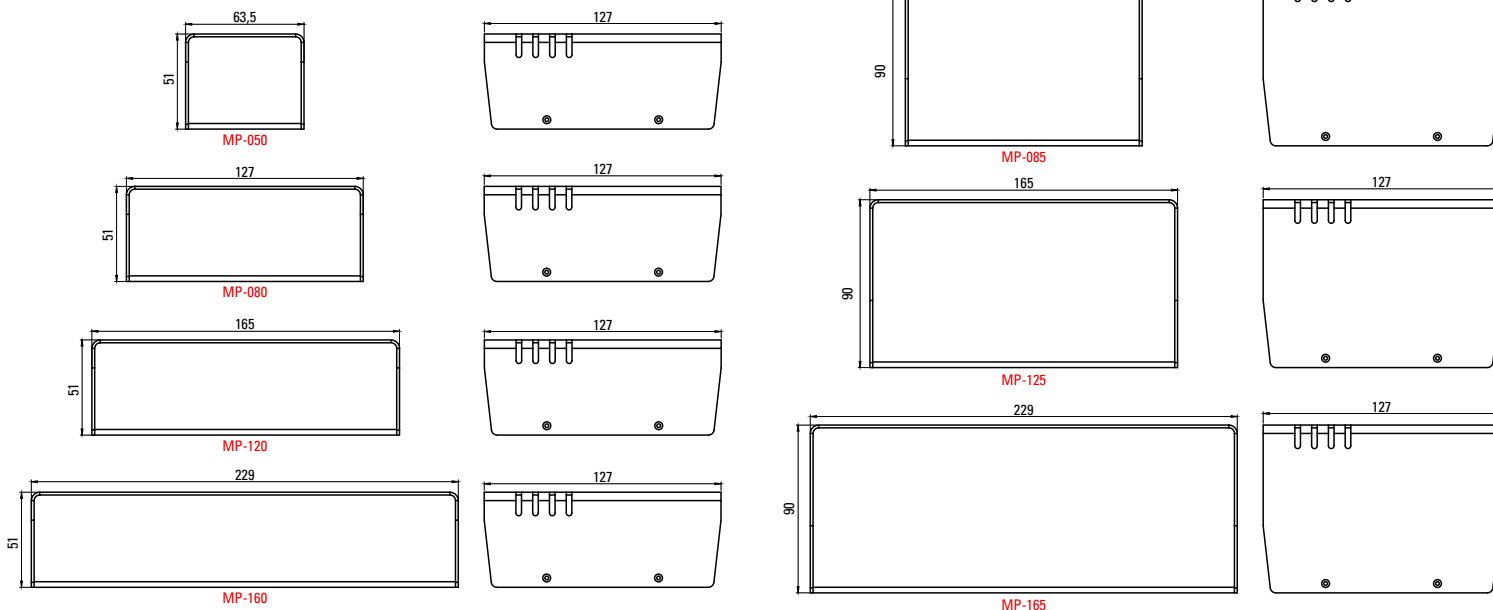



HH-019

USB ENCLOSURE
71 x 23 x 8,7 mm

OTHER ENCLOSURE

MATERIAL ABS
COLOR LIGHT GRAY



OP-010

PHOTOCELL SENSOR
56 x 60 x 66 mm

OTHER ENCLOSURES

MATERIAL
BODY LIGHT GRAY / DARK GRAY / BLACK
CAP PS
PACKAGING 20 PCS/BOX



PE-100

33 x 45 x 50 mm

POTTING ENCLOSURE

PE-100-A

OPEN BASE

PE-100-B

OPEN TOP

MATERIAL ABS-FR
COLOR BLACK
PACKAGING 50 PCS/BOX

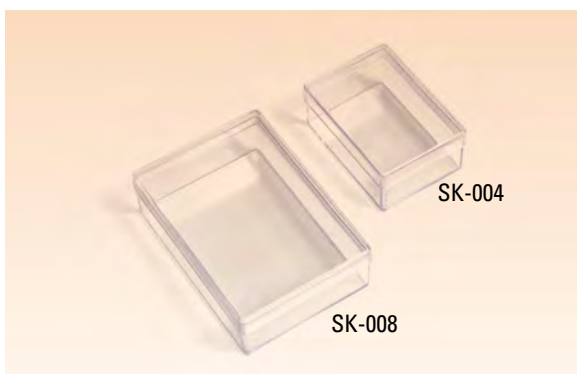

SK-004

71 x 51 x 31 mm

CLEAR PACKAGING ENCLOSURE

SK-008

101 x 71 x 31 mm

SK-010

120 x 80 x 36 mm

MATERIAL SAN
PACKAGING 50 PCS/BOX



DM-034

82 x 80 x 50 mm

WARNING LIGHT ENCLOSURE

MATERIAL ABS - i20
COLOR WHITE
PACKAGING 20 PCS/BOX

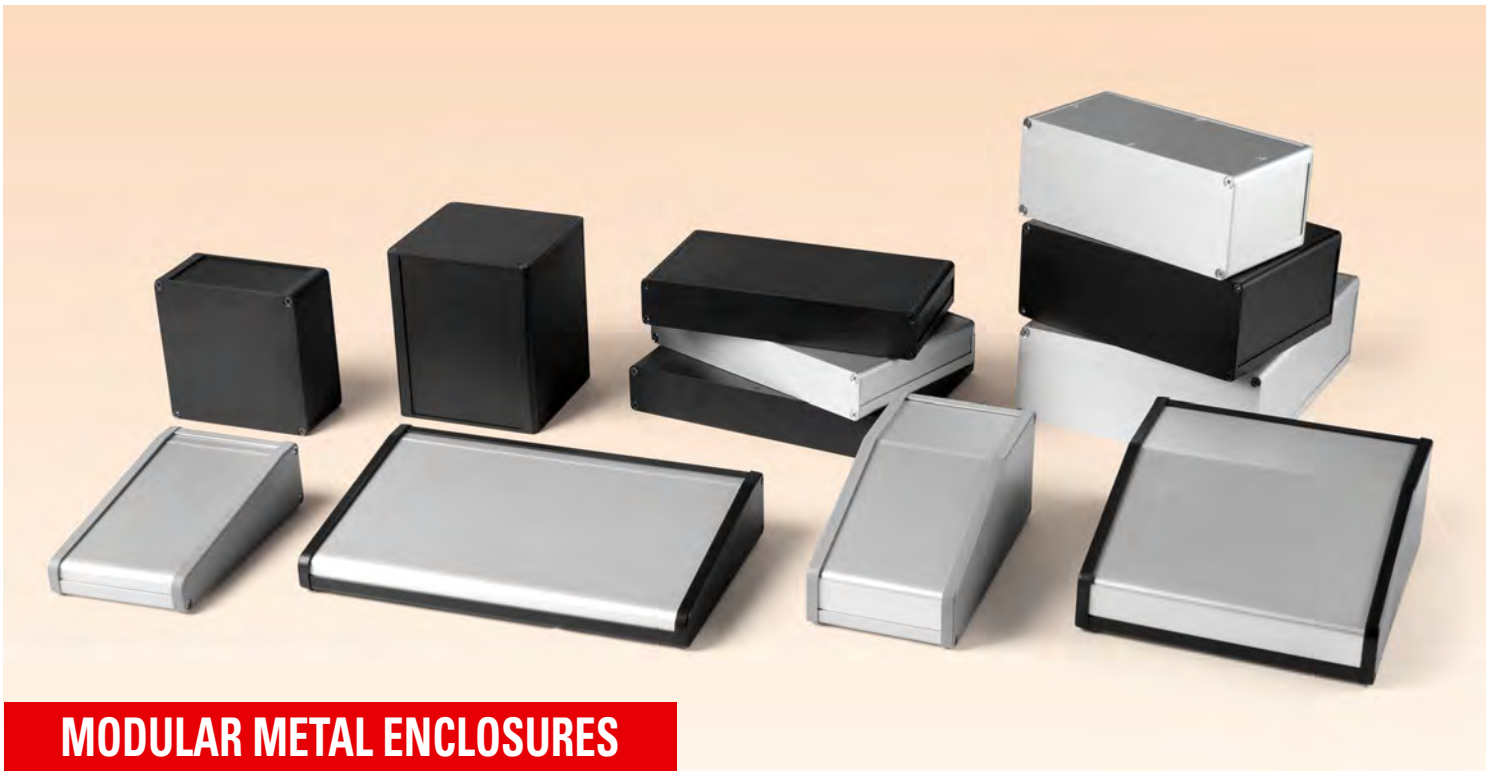

MODULAR METAL ENCLOSURES

- 1,5 mm aluminium sheet
- High quality bending with special die
- Electrostatic powder coating
- Ventilation holes
- MM-239 now with metal side cap option **NEW**

Code	Width (A)	Height (C)	Length (B)
MM-195	192	100-150-200-300-400	57
MM-239	230	100-150-200-300-400	94
MM-135	132,5	60-100-150-200	132,5
MM-228	220	100-150-200-250	88,1
MM-255	250	120-150-200-250	43,65

MM-195 - MM-239

MATERIAL BLACK	ALUMINIUM- ABS Side caps: Black ABS Profiles: Black Electrostatic Powder Coated Aluminium Base and Back Panels: 1,5 mm Black ESPC Aluminium Top Panels: 1,5 mm Natural Anodized Aluminium Side Caps: RAL 7035 Light Gray ABS
NATURAL	Profiles: Natural Anodized Aluminium Base and Top Panels: 1,5 mm Natural Anodized Aluminium

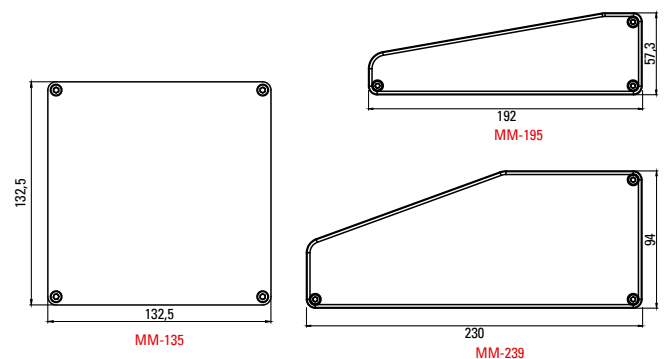

MM-135 - MM-228 & MM-225

MATERIAL BLACK	ALUMINIUM Profiles: Black Electrostatic Powder Coated Aluminium Base and Top Panels: 3 mm Black ESPC Aluminium Side Panels: 1,5 mm Black ESPC Aluminium
NATURAL	Profiles Natural Anodized Aluminium Base and Top Panels: 3 mm Natural Anodized Aluminium Side Panels: 1,5 mm Natural Anodized Aluminium

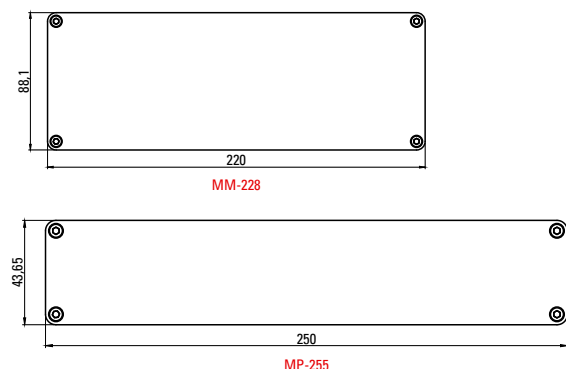

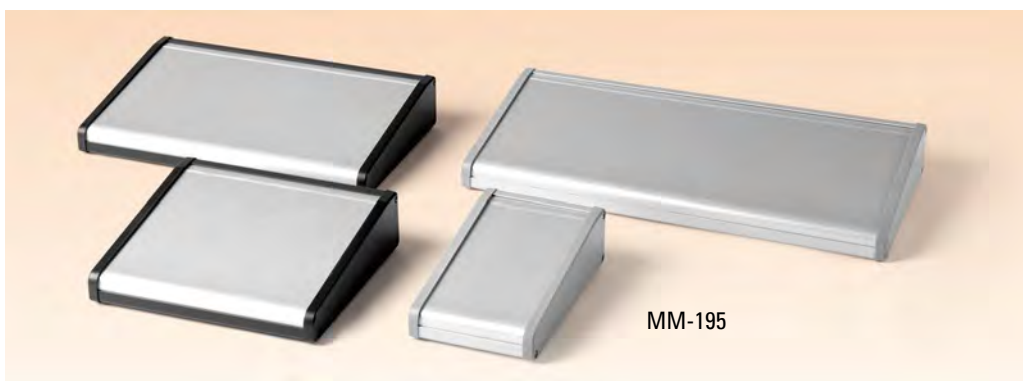

MM-195-10	192 x 57 x 100 mm
MM-195-15	192 x 57 x 150 mm
MM-195-20	192 x 57 x 200 mm
MM-195-30	192 x 57 x 300 mm
MM-195-40	192 x 57 x 400 mm

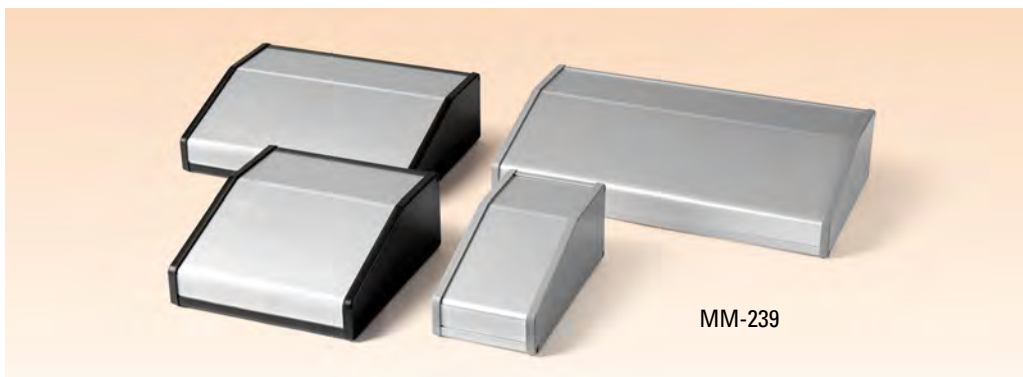

MM-239-10	230 x 94 x 100 mm
MM-239-15	230 x 94 x 150 mm
MM-239-20	230 x 94 x 200 mm
MM-239-30	230 x 94 x 300 mm
MM-239-40	230 x 94 x 400 mm



MM-135-6	132,5 x 132,5 x 60 mm
MM-135-10	132,5 x 132,5 x 100 mm
MM-135-15	132,5 x 132,5 x 150 mm
MM-135-20	132,5 x 132,5 x 200 mm



MM-228-10	220 x 88,1 x 100 mm
MM-228-15	220 x 88,1 x 150 mm
MM-228-20	220 x 88,1 x 200 mm
MM-228-25	220 x 88,1 x 250 mm



MM-255-12	250 x 43,65 x 120 mm
MM-255-15	250 x 43,65 x 150 mm
MM-255-20	250 x 43,65 x 200 mm
MM-255-25	250 x 43,65 x 250 mm

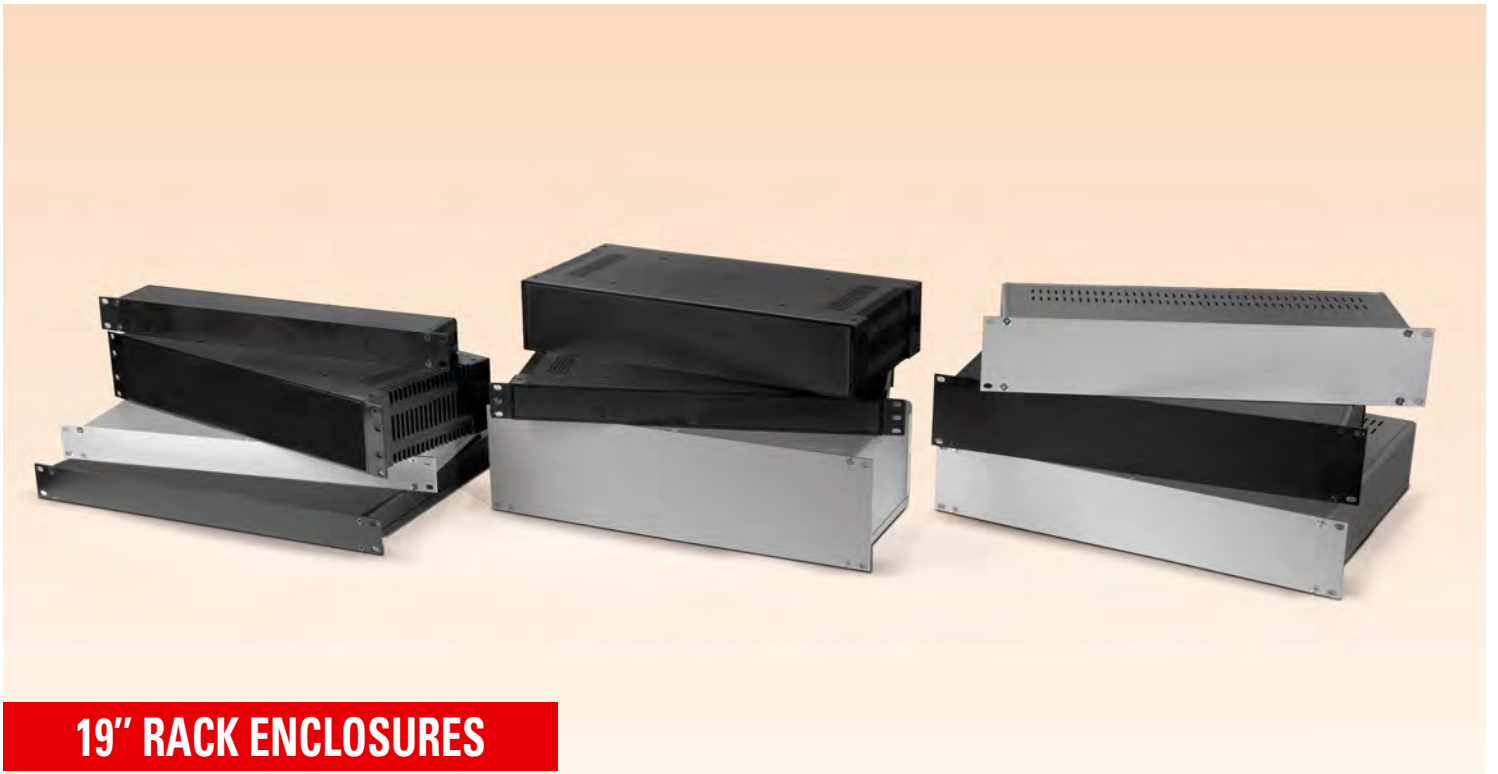

19" RACK ENCLOSURES

RM-110-A
(Old Type)

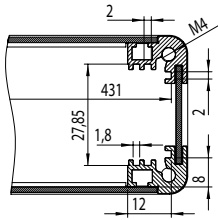

RM-110
(New Type)

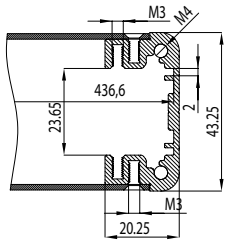

RM-120
(New Type)

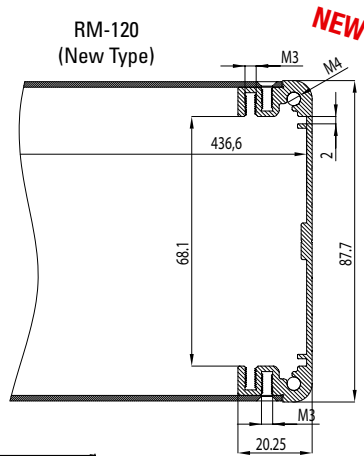

RM-130
(New Type)

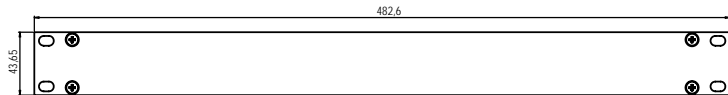
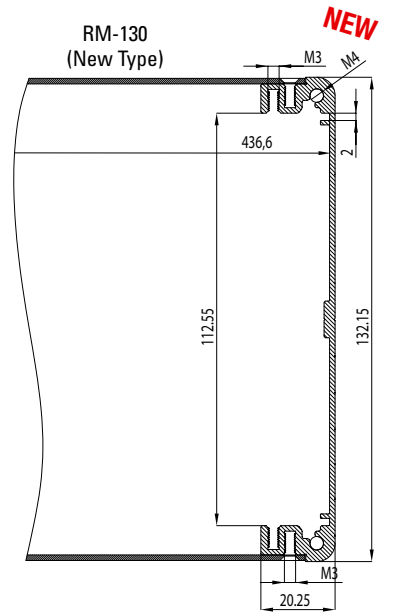

19" 1U

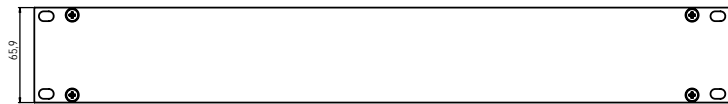

19" 1.5U

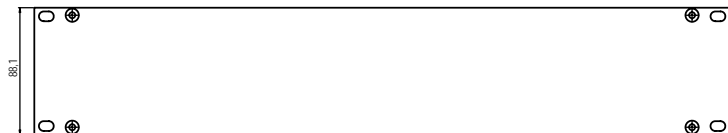

19" 2U



19" 3U

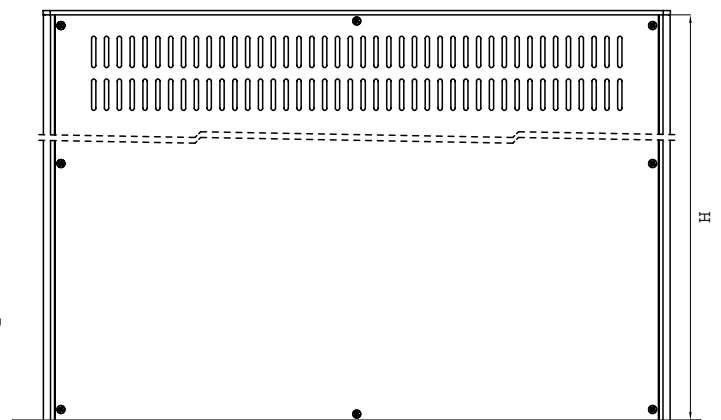



RM-110

RM-110-6

19" 1U RACK MOUNT
482,6 x 43,65 x 66 mm

19" RACK ENCLOSURE

RM-110-14

482,6 x 43,65 x 146 mm

MATERIAL
FRONT-BACK
PANELS

ALUMINIUM

3 mm ALUMINIUM

RM-110-20

482,6 x 43,65 x 206 mm

SIDE PANELS
FEATURE

1,5 mm ALUMINIUM
19" 1U RACK TYPE

RM-110-36

482,6 x 43,65 x 366 mm

COLOR

NATURAL ANODIZED
BLACK POWDER COATING

RM-110-45

482,6 x 43,65 x 456 mm

OPTIONAL VENTILATION

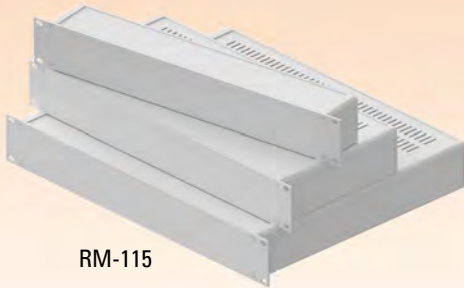

RM-115

RM-115-6

19" 1,5 U RACK MOUNT
482,6 x 65,9 x 66 mm

19" RACK ENCLOSURE

RM-115-14

482,6 x 65,9 x 146 mm

MATERIAL
FRONT-BACK
PANELS

ALUMINIUM

3 mm ALUMINIUM

RM-115-20

482,6 x 65,9 x 206 mm

SIDE PANELS
FEATURE

1,5 mm ALUMINIUM
19" 1,5 U RACK TYPE

RM-115-36

482,6 x 65,9 x 366 mm

COLOR

NATURAL ANODIZED
BLACK POWDER COATING

RM-115-45

482,6 x 65,9 x 456 mm

OPTIONAL VENTILATION



RM-120

RM-120-6

19" 2 U RACK MOUNT
482,6 x 88,1 x 66 mm

19" RACK ENCLOSURE

RM-120-14

482,6 x 88,1 x 146 mm

MATERIAL
FRONT-BACK
PANELS

ALUMINIUM

3 mm ALUMINIUM

RM-120-20

482,6 x 88,1 x 206 mm

SIDE PANELS
FEATURE

1,5 mm ALUMINIUM
19" 2 U RACK TYPE

RM-120-36

482,6 x 88,1 x 366 mm

COLOR

NATURAL ANODIZED
BLACK POWDER COATING

RM-120-45

482,6 x 88,1 x 456 mm

OPTIONAL VENTILATION



RM-130

RM-130-6

19" 3 U RACK MOUNT
482,6 x 132,5 x 66 mm

19" RACK ENCLOSURE

RM-130-14

482,6 x 132,5 x 146 mm

MATERIAL
FRONT-BACK
PANELS

ALUMINIUM

3 mm ALUMINIUM

RM-130-20

482,6 x 132,5 x 206 mm

SIDE PANELS
FEATURE

1,5 mm ALUMINIUM
19" 3 U RACK TYPE

RM-130-36

482,6 x 132,5 x 366 mm

COLOR

NATURAL ANODIZED
BLACK POWDER COATING

RM-130-45

482,6 x 132,5 x 456 mm

OPTIONAL VENTILATION



A-320

A-322

A-324

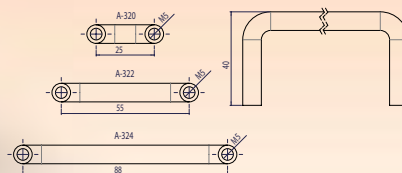

A-320

Handle for 1 U
Enclosure

A-322

Handle for 2 U
Enclosure

A-324

Handle for 3 U
Enclosure



RM-201

RM-201

431 x 203 x 44 mm

19" PLASTIC RACK ENCLOSURE

MATERIAL	ABS
FEATURE	19" 1U RACK TYPE
COLOR	BLACK
PACKAGING	1 PCS/BOX



RM-202

RM-202

431 x 203 x 88 mm

19" PLASTIC RACK ENCLOSURE

MATERIAL	ABS
FEATURE	19" 2U RACK TYPE
COLOR	BLACK
PACKAGING	1 PCS/BOX



RM-203

RM-203

431 x 203 x 132 mm

19" PLASTIC RACK ENCLOSURE

MATERIAL	ABS
FEATURE	19" 3U RACK TYPE
COLOR	BLACK
PACKAGING	1 PCS/BOX

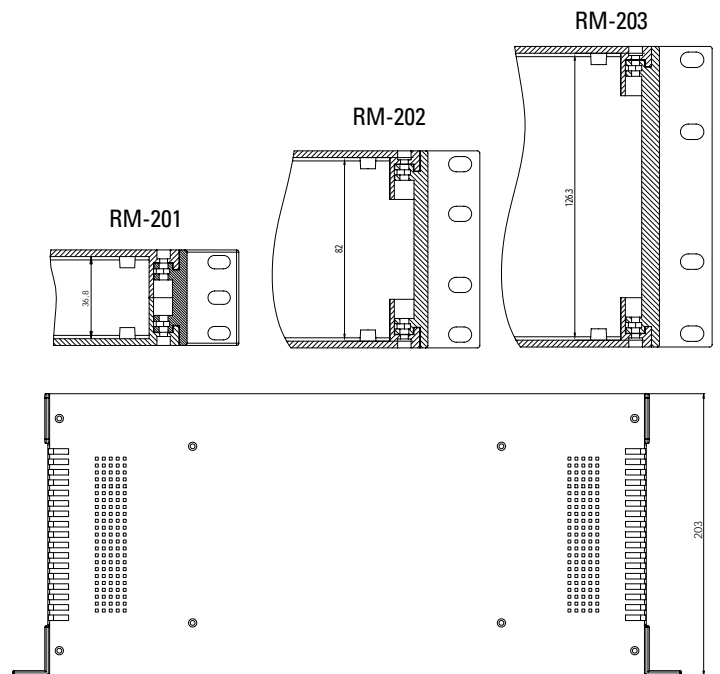
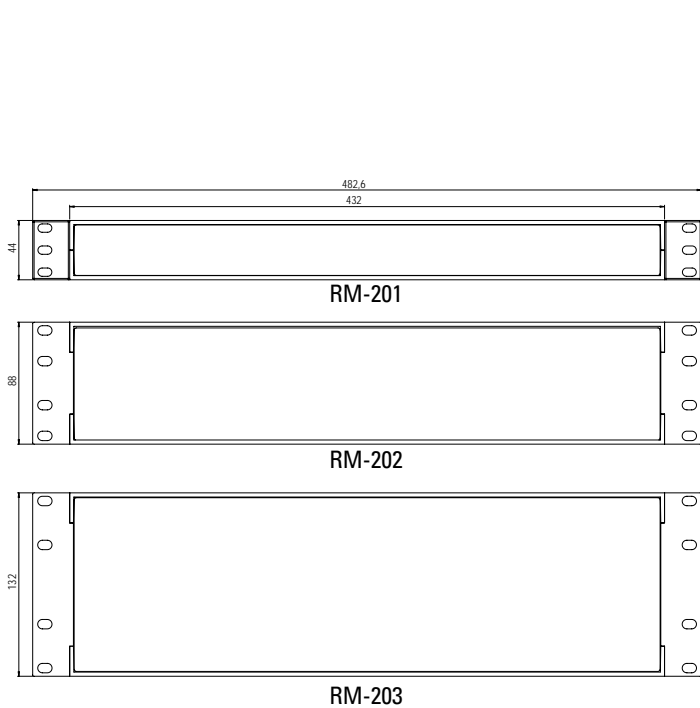

NEW



ALUMINIUM LABORATORY ENCLOSURE

- All metal design
- Frame: Aluminium Injection
- Side Panel: Aluminium Profile
- Bottom and Top Panel: 1.5 mm Aluminium Panel

- Front and Back Panel: 2 mm Aluminium Panel
- Galvanized Internal Mild Steel Mounting Plate
- Stainless Inox Screws
- New sizes are under development

DT-550

364 x 333 x 146 mm

MATERIAL	ALUMINIUM
COLOR	GRAY / BLACK
SURFACE	ELECTROSTATIC POWDER COATED
PACKAGING	1 PCS/BOX

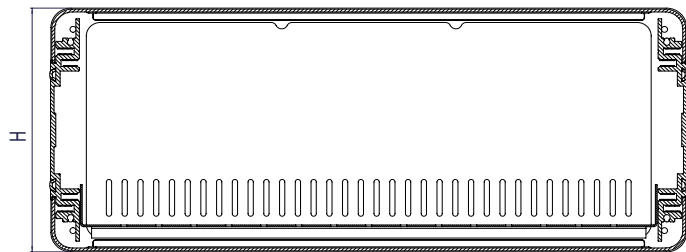

Section A-A

DT-552

364 x 482 x 146 mm

MATERIAL	ALUMINIUM
COLOR	GRAY / BLACK
SURFACE	ELECTROSTATIC POWDER COATED
PACKAGING	1 PCS/BOX

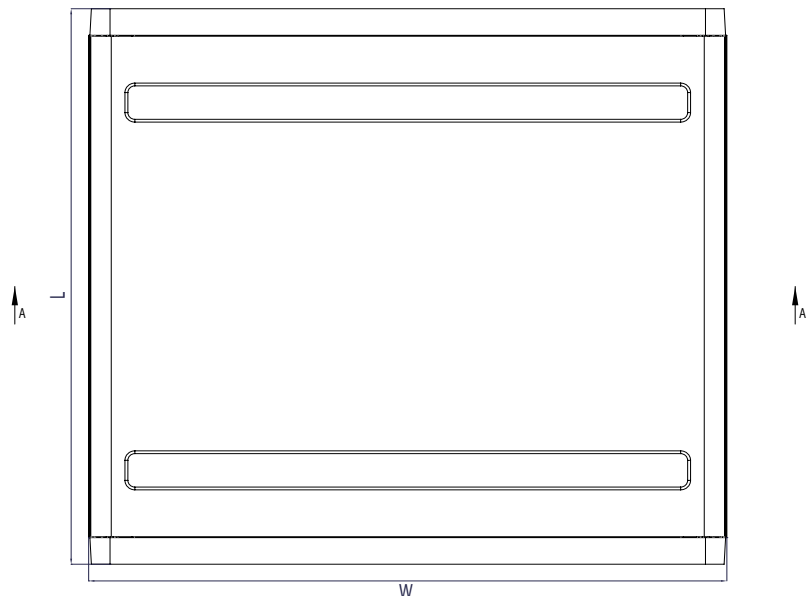

Code	W	L	H
DT-550	364	333	146
DT-552	364	482	146



DESKTOP LABORATORY ENCLOSURES

- Plastic and metal hybrid design
- High quality ABS material
- Electrostatic powder coated 1,5 mm aluminium body
- Easy mounting with perforated, galvanized internal mild steel mounting plate
- Optional carrying handle with 15 degrees steps
- Sloped standing option with optional tilting foot
- Easy carriage with optional metal handle
- Useful for laboratory, medical measurement, measuring and control systems, power supplies and educational sets
- Customizable panels

Code	Width (A)	Length (B)	Height (C)	Handle
DT-330	187	173	87	
DT-335	187	282	87	
DT-335-K	187	282	87	YES
DT-340	288	163	105	
DT-345	288	271	105	
DT-345-K	288	271	105	YES
DT-346	350	159	115	
DT-348	350	288	115	
DT-348-K	350	288	115	YES
DT-350	288	165	150	
DT-355	288	274	150	
DT-355-K	288	274	150	YES
DT-360	438	165	150	
DT-365	438	275	150	
DT-365-K	438	275	150	YES

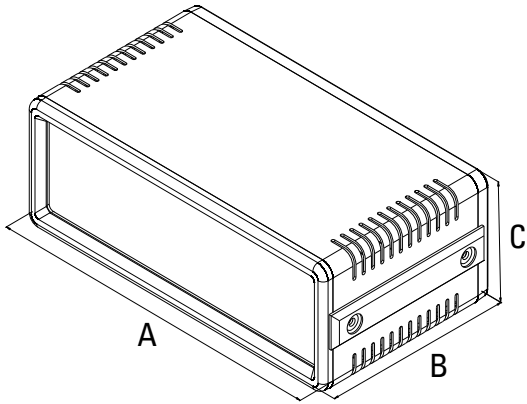

METAL HANDLE
 A-97 185 mm axial distance
 A-98 132 mm axial distance



DT-330

DT-330 187 x 173 x 87 mm **DESKTOP LABORATORY ENCLOSURE**

MATERIAL		SUITABLE ACCESSORIES
PLASTICS	ABS	A-951 TILTING FOOT
BODY	ALUMINIUM	A-98 HANDLE
PAINT	ELECTROSTATIC COATING	
COLOR	LIGHT GRAY - DARK GRAY	
PACKAGING	1 PCS/BOX	

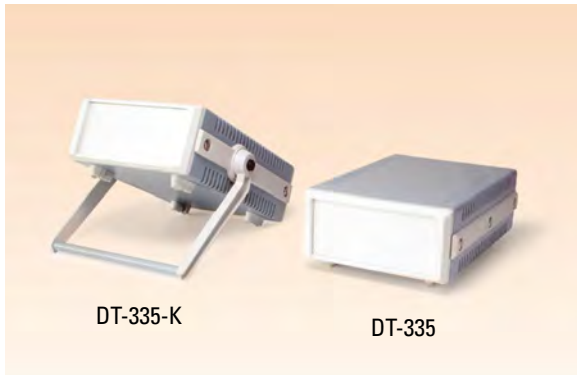

DT-335-K

DT-335

DT-335 STANDARD 187 x 282 x 87 mm **DESKTOP LABORATORY ENCLOSURE**

DT-335-K W/ HANDLE **SUITABLE ACCESSORIES**

MATERIAL		A-951 TILTING FOOT
PLASTICS	ABS	A-97 HANDLE
BODY	ALUMINIUM	A-98 HANDLE
PAINT	ELECTROSTATIC COATING	
COLOR	LIGHT GRAY - DARK GRAY	
PACKAGING	1 PCS/BOX	



DT-340

DT-340 288 x 163 x 105 mm **DESKTOP LABORATORY ENCLOSURE**

MATERIAL		SUITABLE ACCESSORIES
PLASTICS	ABS	A-951 TILTING FOOT
BODY	ALUMINIUM	A-97 HANDLE
PAINT	ELECTROSTATIC COATING	A-98 HANDLE
COLOR	LIGHT GRAY - DARK GRAY	
PACKAGING	1 PCS/BOX	



DT-345-K

DT-345

DT-345 288 x 271 x 105 mm **DESKTOP LABORATORY ENCLOSURE**

DT-345-K W/ HANDLE **SUITABLE ACCESSORIES**

MATERIAL		A-951 TILTING FOOT
PLASTICS	ABS	A-97 HANDLE
BODY	ALUMINIUM	A-98 HANDLE
PAINT	ELECTROSTATIC COATING	
COLOR	LIGHT GRAY - DARK GRAY	
PACKAGING	1 PCS/BOX	



DT-346

DT-346 350 x 159 x 115 mm **DESKTOP LABORATORY ENCLOSURE**

MATERIAL		SUITABLE ACCESSORIES
PLASTICS	ABS	A-951 TILTING FOOT
BODY	ALUMINIUM	A-97 HANDLE
PAINT	ELECTROSTATIC COATING	A-98 HANDLE
COLOR	LIGHT GRAY - DARK GRAY	
PACKAGING	1 PCS/BOX	

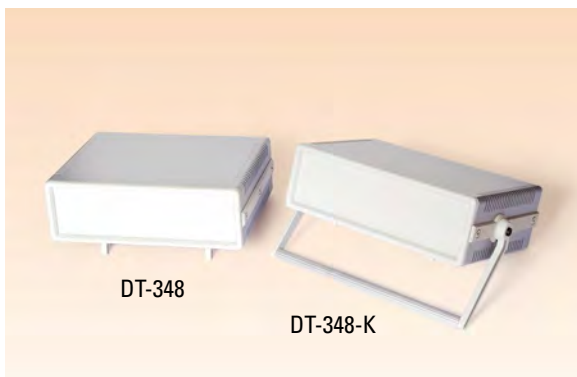

DT-348

STANDARD
350 x 288 x 115 mm

DESKTOP LABORATORY ENCLOSURE

DT-348-K

W/ HANDLE

SUITABLE ACCESSORIES

- A-951 TILTING FOOT
- A-97 HANDLE
- A-98 HANDLE

MATERIAL	
PLASTICS	ABS
BODY	ALUMINIUM
PAINT	ELECTROSTATIC COATING
COLOR	LIGHT GRAY - DARK GRAY
PACKAGING	1 PCS/BOX



DT-350

STANDARD
288 x 165 x 150 mm

DESKTOP LABORATORY ENCLOSURE

MATERIAL	
PLASTICS	ABS
BODY	ALUMINIUM
PAINT	ELECTROSTATIC COATING
COLOR	LIGHT GRAY - DARK GRAY
PACKAGING	1 PCS/BOX

SUITABLE ACCESSORIES

- A-951 TILTING FOOT
- A-97 HANDLE
- A-98 HANDLE

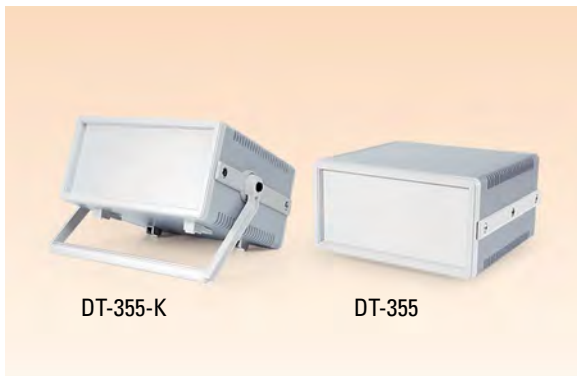

DT-355

274 x 288 x 150 mm

DESKTOP LABORATORY ENCLOSURE

DT-355-K

W/ HANDLE

SUITABLE ACCESSORIES

- A-951 TILTING FOOT
- A-97 HANDLE
- A-98 HANDLE

MATERIAL	
PLASTICS	ABS
BODY	ALUMINIUM
PAINT	ELECTROSTATIC COATING
COLOR	LIGHT GRAY - DARK GRAY
PACKAGING	1 PCS/BOX



DT-360

438 x 165 x 150 mm

DESKTOP LABORATORY ENCLOSURE

MATERIAL	
PLASTICS	ABS
BODY	ALUMINIUM
PAINT	ELECTROSTATIC COATING
COLOR	LIGHT GRAY - DARK GRAY
PACKAGING	1 PCS/BOX

SUITABLE ACCESSORIES

- A-951 TILTING FOOT
- A-97 HANDLE
- A-98 HANDLE



DT-365

STANDARD
438 x 275 x 150 mm

DESKTOP LABORATORY ENCLOSURE

DT-365-K

W/ HANDLE

SUITABLE ACCESSORIES

- A-951 TILTING FOOT
- A-97 HANDLE
- A-98 HANDLE

MATERIAL	
PLASTICS	ABS
BODY	ALUMINIUM
PAINT	ELECTROSTATIC COATING
COLOR	LIGHT GRAY - DARK GRAY
PACKAGING	1 PCS/BOX

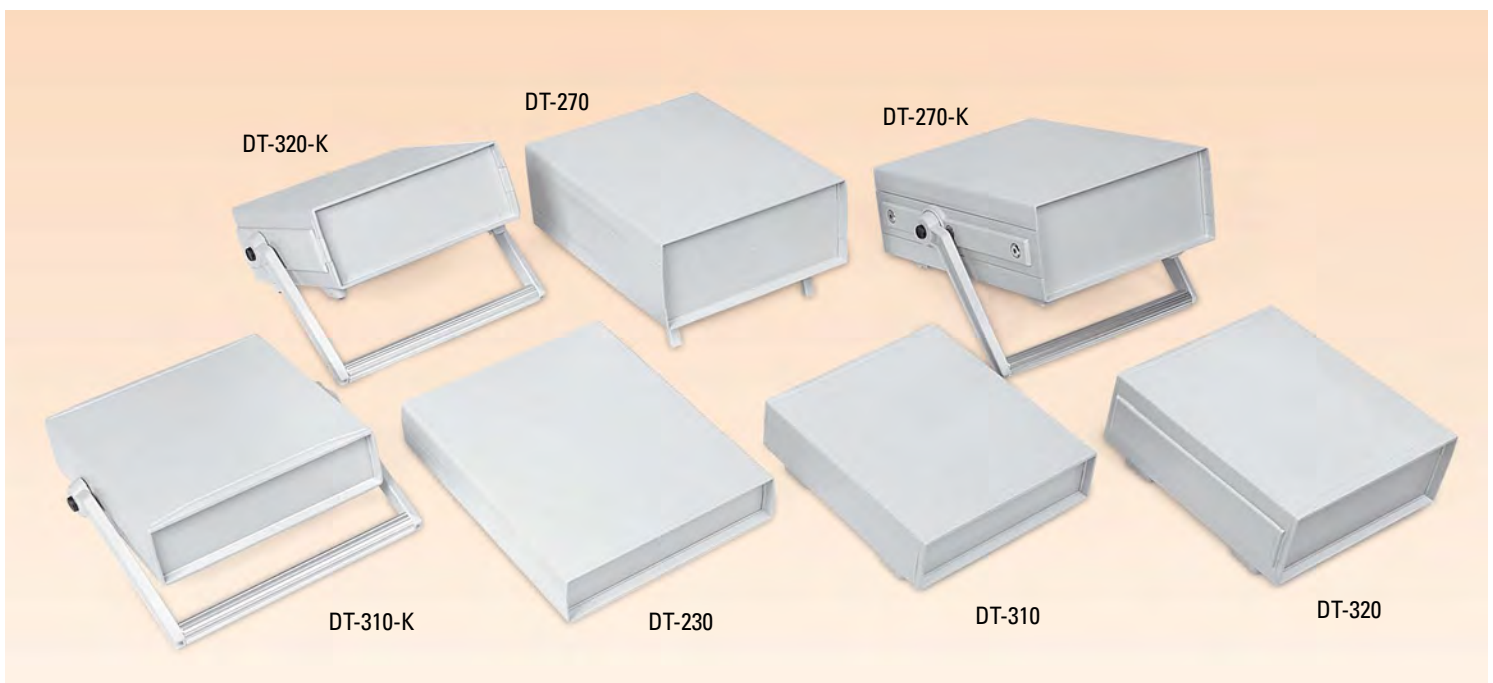

PLASTIC LABORATORY ENCLOSURES



DT-230

DT-230

228 x 285 x 52 mm

PLASTIC LABORATORY ENCLOSURE

MATERIAL	ABS
COLOR	LIGHT GRAY
PACKAGING	1 PCS/BOX

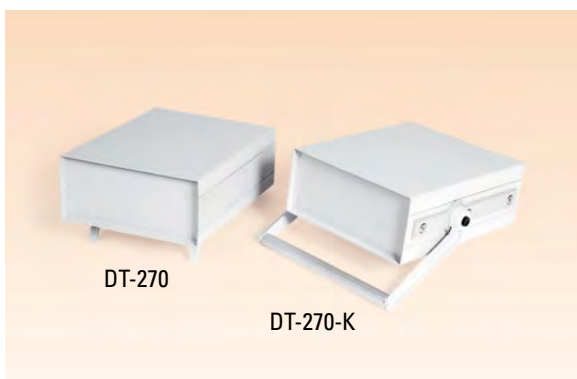

DT-270

DT-270-K

DT-270

STANDARD
228 x 285 x 100 mm

PLASTIC LABORATORY ENCLOSURE

DT-270-K

W/ HANDLE

SUITABLE ACCESSORIES

- A-951 TILTING FOOT
- A-93 WIRE FOOT

MATERIAL	ABS
COLOR	LIGHT GRAY
PACKAGING	1 PCS/BOX

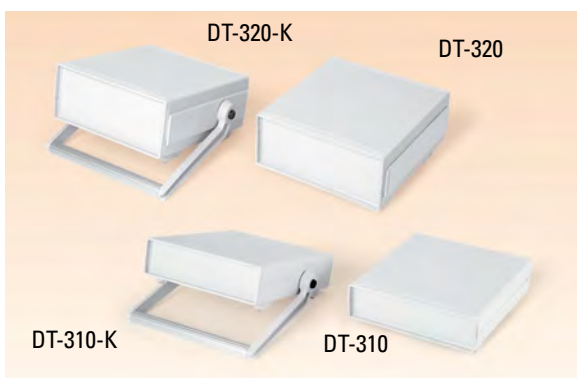

DT-310-K

DT-310

DT-320-K

DT-320

DT-310

STANDARD
212 x 230 x 64 mm

PLASTIC LABORATORY ENCLOSURE

DT-310-K

W/ HANDLE

MATERIAL	ABS
COLOR	LIGHT GRAY
PACKAGING	1 PCS/BOX

DT-320

STANDARD
220 x 230 x 87

SUITABLE ACCESSORIES

- A-951 TILTING FOOT
- A-93 WIRE FOOT

DT-320-K

W/ HANDLE



SLOPED LABORATORY ENCLOSURES

- Plastic and metal hybrid design
- High quality ABS material
- Electrostatic powder coated 1 mm mild steel body
- Perforated, galvanized internal mild steel mounting plate
- Sloped standing option with optional tilting foot
- Useful for laboratory, medical measurement, measuring and control systems, power supplies and educational sets
- Easy carriage with optional metal handle
- Customizable panels



METAL HANDLE
 A-97 185 mm Axial distance
 A-98 132 mm Axial distance

Code	Width (A)	Length (B)	Height (C)
DT-460	273	315	201
DT-458	273	206	201
DT-455	189	290	133
DT-450	189	181	133
DT-433	188	282	134
DT-430	188	173	134
DT-428	188	124	134
DT-422	134	283	189
DT-420	134	173	189

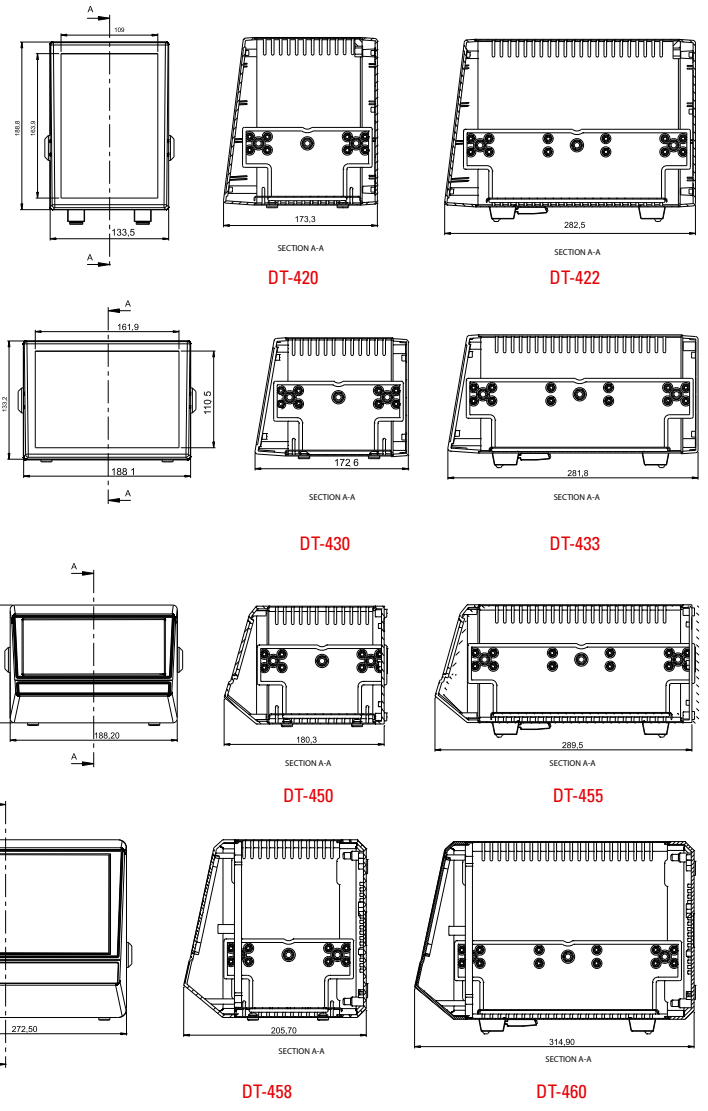



DT-420

DT-420

134 x 173 x 189 mm

SLOPED LABORATORY ENCLOSURE

MATERIAL	
PLASTICS	ABS
BODY	METAL SHEET
PAINT	ELECTROSTATIC COATING
COLOR	GRAY
PACKAGING	1 PCS/BOX



DT-422

DT-422

134 x 283 x 189 mm

SLOPED LABORATORY ENCLOSURE

MATERIAL	
PLASTICS	ABS
BODY	METAL SHEET
PAINT	ELECTROSTATIC COATING
COLOR	GRAY
PACKAGING	1 PCS/BOX



DT-428

DT-428

188 x 124 x 134 mm

SLOPED LABORATORY ENCLOSURE

MATERIAL	
PLASTICS	ABS
BODY	METAL SHEET
PAINT	ELECTROSTATIC COATING
COLOR	GRAY
PACKAGING	1 PCS/BOX



DT-430

DT-430

188 x 173 x 134 mm

SLOPED LABORATORY ENCLOSURE

MATERIAL	
PLASTICS	ABS
BODY	METAL SHEET
PAINT	ELECTROSTATIC COATING
COLOR	GRAY
PACKAGING	1 PCS/BOX



DT-433

DT-433

188 x 282 x 134 mm

SLOPED LABORATORY ENCLOSURE

MATERIAL	
PLASTICS	ABS
BODY	METAL SHEET
PAINT	ELECTROSTATIC COATING
COLOR	GRAY
PACKAGING	1 PCS/BOX



DT-450

DT-450

189 x 181 x 133 mm

SLOPED LABORATORY ENCLOSURE

MATERIAL

PLASTICS ABS

BODY METAL SHEET

PAINT ELECTROSTATIC COATING

COLOR GRAY

PACKAGING 1 PCS/BOX



DT-455

DT-455

189 x 290 x 133 mm

SLOPED LABORATORY ENCLOSURE

MATERIAL

PLASTICS ABS

BODY METAL SHEET

PAINT ELECTROSTATIC COATING

COLOR GRAY

PACKAGING 1 PCS/BOX



DT-458

DT-458

273 x 206 x 201 mm

SLOPED LABORATORY ENCLOSURE

MATERIAL

PLASTICS ABS

BODY METAL SHEET

PAINT ELECTROSTATIC COATING

COLOR GRAY

PACKAGING 1 PCS/BOX



DT-460

DT-460

273 x 315 x 201 mm

SLOPED LABORATORY ENCLOSURE

MATERIAL

PLASTICS ABS

BODY METAL SHEET

PAINT ELECTROSTATIC COATING

COLOR GRAY

PACKAGING 1 PCS/BOX



POWER SUPPLY ENCLOSURE



DT-410

DT-410

126 x 258 x 145 mm

POWER SUPPLY ENCLOSURE

DT-410-K	CLOSED FRONT PANEL
DT-410-A	OPEN FRONT PANEL
MATERIAL	1 mm METAL SHEET
PANEL	ABS
COLOR	RAL 7035 LIGHT GRAY
PACKAGING	1 PCS/BOX

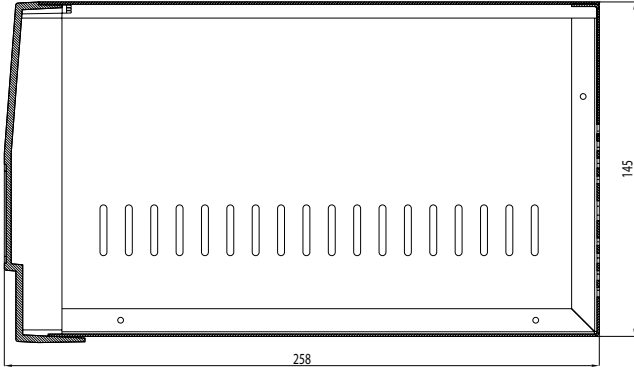
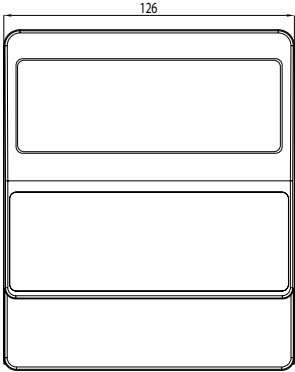

• Perforated for power input and fan

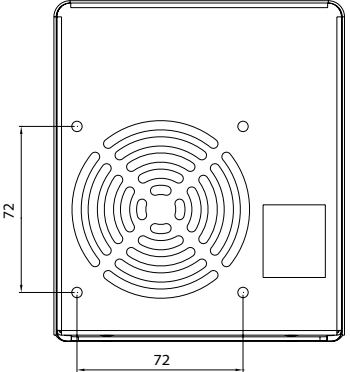

METAL HANDLE
 A-97 185 mm Axial distance
 A-98 132 mm Axial distance



NEW



IP-67 PLASTIC ENCLOSURE

- IP-67 waterproof
- Shockproof ABS material
- Stainless steel latches
- 1 mm galvanized mild steel mounting plate
- Changable TPE gasket
- Aluminium wall mounting lugs
- Optional pole mounting kit
- Lugs for padlock
- Optional inner door set



Stainless Steel Screws



Stainless Steel Latches



Galvanized Mounting plate



Light Gray ABS Material



IP - 67 Waterproof Design



Lugs for Padlock

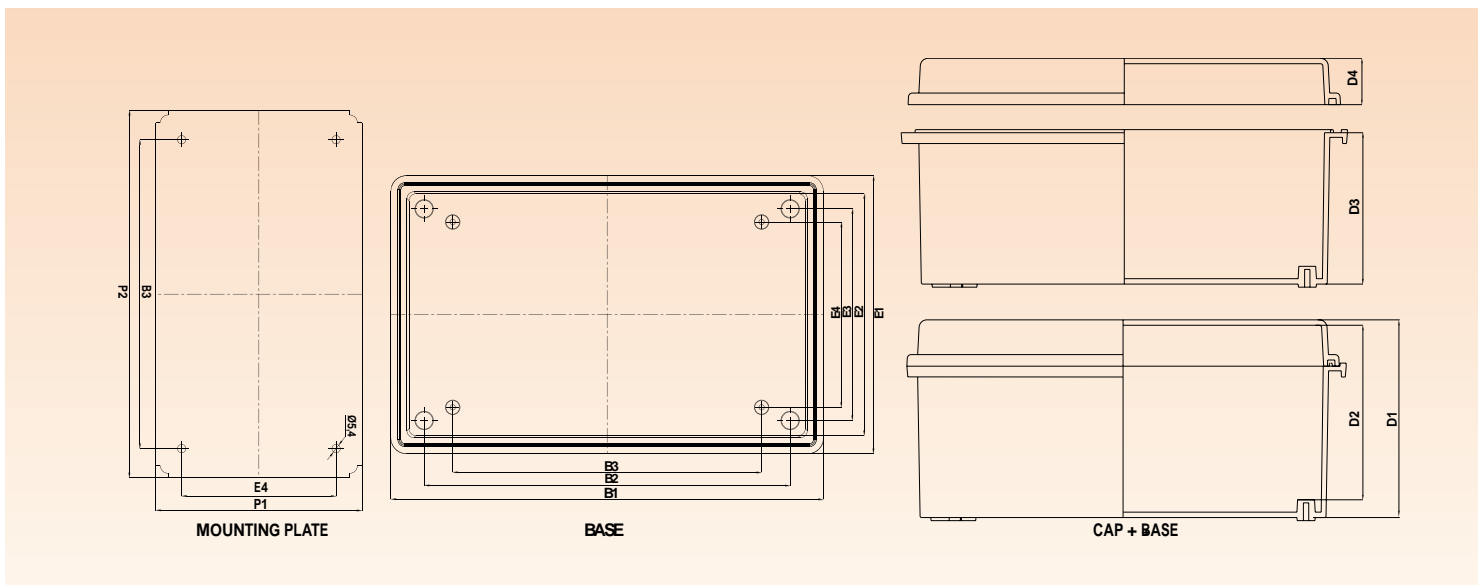

	Code	Measures	E1	E2	E3	E4	B1	B2	B3	D1	D2	D3	D4	P1	P2
NEW	EC-912-7	90 x 120 x 70	90	68	48	50	120	78	80	70	57	50	20	68	98
NEW	EC-912-9	90 x 120 x 90	90	68	48	50	120	78	80	90	77	70	20	68	98
	EC - 1515-9	150 x 150 x 89	150	128	108	108	150	108	108	89	76	69	20	124	124
NEW	EC - 1318-10	130 x 180 x 100	130	112	95	90	180	145	100	100	87	80	20	102	152
	EC - 1722-13	170 x 220 x 127	170	146	127	110	220	177	80	127	112	97	30	134	184
NEW	EC-2121-10	210 x 210 x 100	210	187	167	160	210	167	120	100	86	70	30	190	190
NEW	EC-2121-13	210 x 210 x 130	210	186	167	160	210	167	120	130	116	100	30	190	190
	EC - 2535-13	250 x 350 x 127	250	226	207	180	350	307	280	127	113	97	30	210	310
	EC - 2818-13	180 x 280 x 127	180	156	137	120	280	237	200	127	112	97	30	133	238
	EC - 2828-13	280 x 280 x 127	280	256	237	200	280	237	200	127	112	97	30	238	238
	EC - 3040-16	300 x 400 x 159	300	264	250	220	400	350	320	159	142	129	30	242	343
	EC - 4050-20	400 x 500 x 200	400	368	348,5	300	500	448,5	400	200	186	170	30	350	450

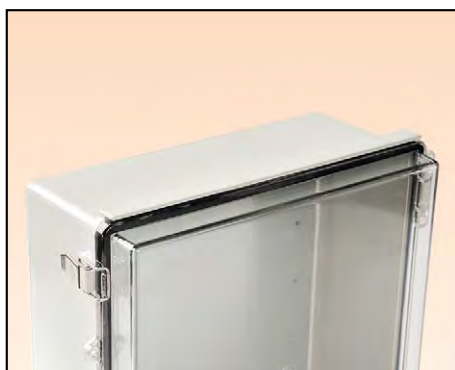

Transparent Polycarbonate Lid Option



Weatherproof ASA Material Option

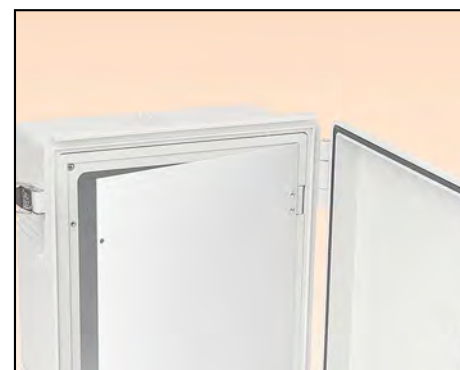

Inner Door Set Option



Pole Mounting Kit Option



Aluminium Wall Mounting Lugs Option



Plastic Wall Mounting Lugs Option

ACCESSORIES

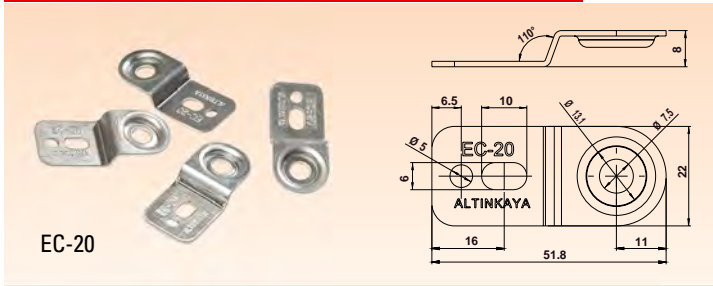

EC-20

Aluminium Wall Mounting Lugs

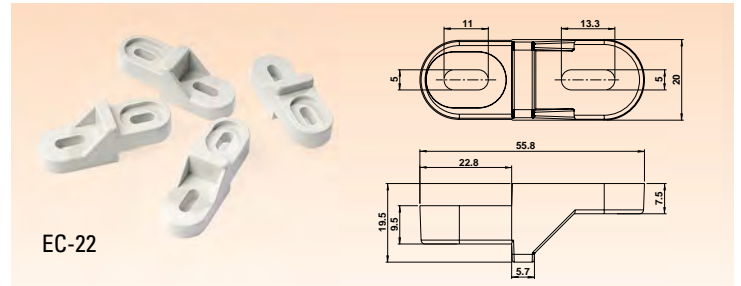

EC-22

Plastic Wall Mounting Lugs

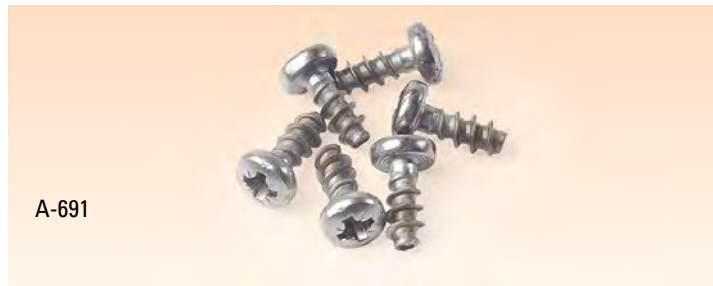

A-691

Suitable Stainless Screws
A-691 4x9 mm YBS-PZ

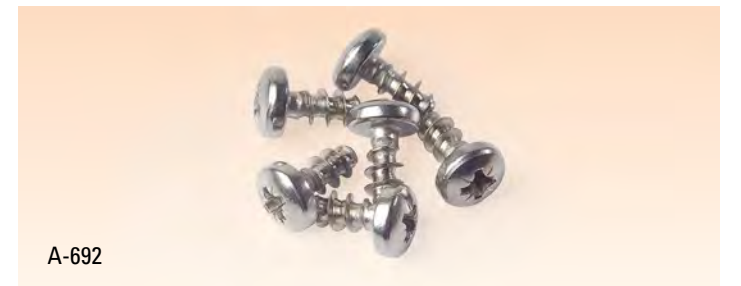

A-692

Suitable Stainless Screws
A-692 5x10 mm YBS-PZ



Galvanized Mild Steel Mounting Plate

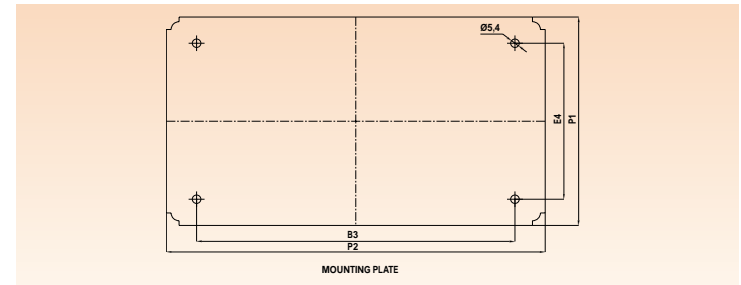

Mounting Plate

Code	Suitable Enclosure	P1	P2	E4	B3
EC - 912 - 7 - G	EC - 912 - 7	68	98	50	80
EC - 912 - 9 - G	EC - 912 - 9	68	98	50	80
EC - 1515 - G	EC - 1515	124	124	108	108
EC - 1318 - G	EC - 1318	102	152	90	100
EC - 1722 - G	EC - 1722	134	184	110	80
EC - 2121- 10 - G	EC - 2121-10	190	190	160	120
EC - 2121- 13 - G	EC - 2121-13	190	190	160	120
EC - 2535 - G	EC - 2535	210	310	180	280
EC - 2818 - G	EC - 2818	133	238	120	200
EC - 2828 - G	EC - 2828	238	238	200	200
EC - 3040 - G	EC - 3040	242	343	220	320
EC - 4050 - G	EC - 4050	350	450	300	400

ACCESSORIES



A-260

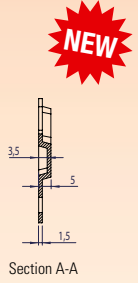
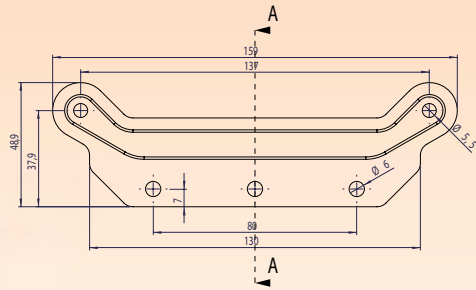

A-262

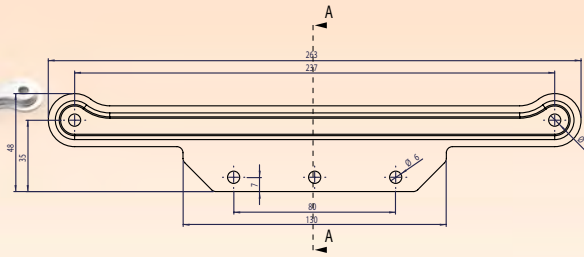

PH-100
PLASTIC VENTILATION

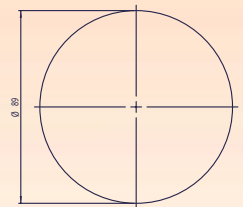
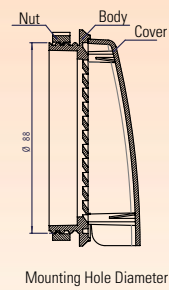
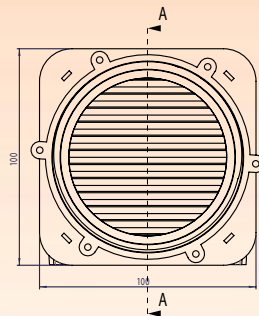

POLE MOUNTING KITS



EC-24
For Small Size Enclosures

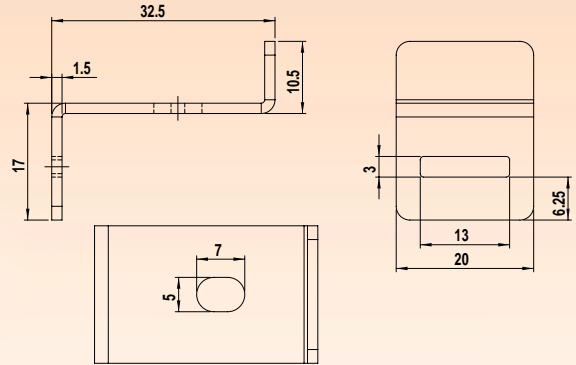

EC-25
For Medium Size Enclosures

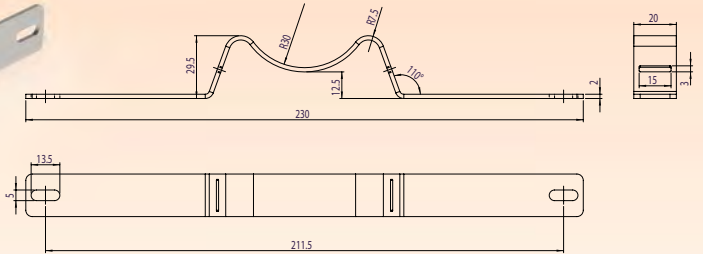
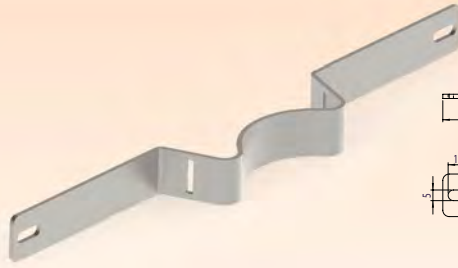

EC-26
For Medium Size Enclosures

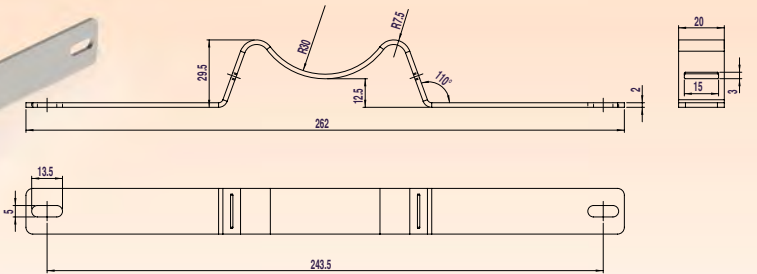
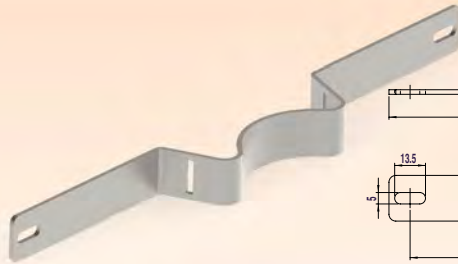

EC-28
For Big Size Enclosures

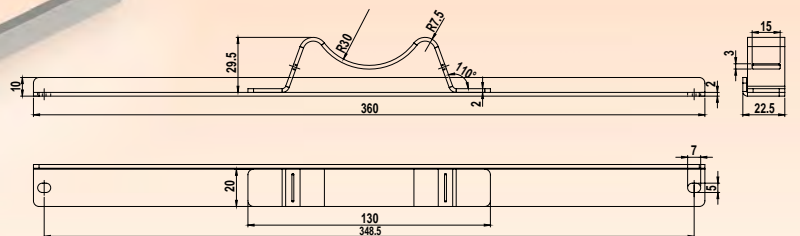

NEW



TB-520



TB-204



TB-1865

IP-67 ENCLOSURE WITH CABLE GLAND



TB-204

NEW

TB-204

80 x 50 x 25 mm

IP-67 ENCLOSURE WITH CABLE GLAND

TB-204-A

DOUBLE GLAND

MATERIAL ABS V0

COLOR LIGHT GRAY

PACKAGING 20 PCS/BOX

TB-204-B

SINGLE GLAND



TB-520

NEW

TB-520

82,5 x 65 x 45 mm

IP-67 ENCLOSURE WITH CABLE GLAND

MATERIAL ABS V0

COLOR LIGHT GRAY

PACKAGING 20 PCS/BOX



TB-1865

NEW

TB-1865

180 x 65 x 45 mm

IP-67 ENCLOSURE WITH CABLE GLAND

MATERIAL ABS V0

COLOR LIGHT GRAY

PACKAGING 20 PCS/BOX

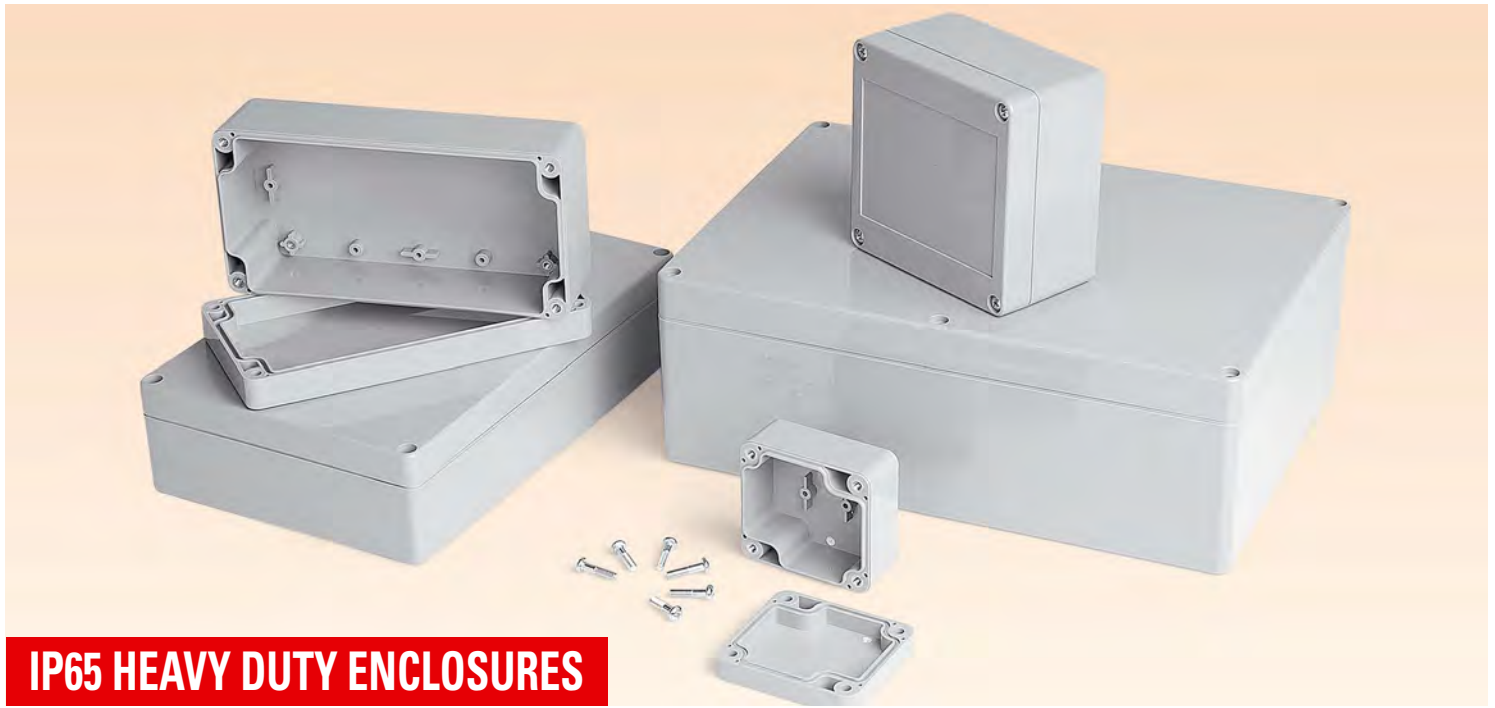

IP65 HEAVY DUTY ENCLOSURES

- IP-65 protection class, sealed waterproof enclosure
- ABS material
- TPE continuous seal
- Lid screws and wall mounting holes are outside sealed area to satisfy IP-65 protection to dust, liquid and moisture
- With brass inserts you can open and close the enclosure thousands of times
- M4 stainless cover screws
- RoHS compliant

CODE	W	L	H	PROTECTION CLASS	DESCRIPTION
SE-202	52	50	35	IP-65	Dark Gray ABS
NEW HINGED SH-203	48	57	41	IP-65	Dark Gray ABS
SE-204	64	58	35	IP-65	Dark Gray ABS
SE-205	64	68	35	IP-65	Dark Gray ABS
SE-206	82	80	55	IP-65	Dark Gray ABS
SE-208	184	36	35	IP-65	Dark Gray ABS
SE-210	115	65	40	IP-65	Dark Gray ABS
SE-035	115	65	55	IP-65	Dark Gray ABS
SE-212	115	65	55	IP-65	Dark Gray ABS
SE-214	120	80	55	IP-65	Dark Gray ABS
SE-216	120	80	85	IP-65	Dark Gray ABS
SE-218	100	100	55	IP-65	Dark Gray ABS
SE-220	100	100	90	IP-65	Dark Gray ABS
SE-222	115	90	55	IP-65	Dark Gray ABS
SE-224	115	90	80	IP-65	Dark Gray ABS
SE-225	160	80	40	IP-65	Dark Gray ABS
SE-226	160	80	55	IP-65	Dark Gray ABS
SE-228	160	80	85	IP-65	Dark Gray ABS
SE-230	120	120	60	IP-65	Dark Gray ABS
SE-232	120	120	90	IP-65	Dark Gray ABS
SE-234	195	80	55	IP-65	Dark Gray ABS
SE-236	171	121	55	IP-65	Dark Gray ABS
SE-050	171	121	55	IP-65	Dark Gray ABS

CODE	W	L	H	PROTECTION CLASS	DESCRIPTION
SE-056	175	90	100	IP-65	Dark Gray ABS
SE-238	171	121	80	IP-65	Dark Gray ABS
SE-240	200	120	75	IP-65	Dark Gray ABS
SE-242	200	120	90	IP-65	Dark Gray ABS
SE-244	160	160	60	IP-65	Dark Gray ABS
SE-246	160	160	90	IP-65	Dark Gray ABS
SE-248	240	120	60	IP-65	Dark Gray ABS
SE-249	190	190	55	IP-65	Dark Gray ABS
SE-250	240	120	100	IP-65	Dark Gray ABS
SE-252	200	150	55	IP-65	Dark Gray ABS
SE-254	200	150	75	IP-65	Dark Gray ABS
SE-256	222	146	55	IP-65	Dark Gray ABS
SE-258	222	146	75	IP-65	Dark Gray ABS
SE-259	215	175	55	IP-65	Dark Gray ABS
SE-260	240	160	90	IP-65	Dark Gray ABS
SE-262	240	160	120	IP-65	Dark Gray ABS
SE-264	265	185	95	IP-65	Dark Gray ABS
SE-266	353	140	121,5	IP-65	Dark Gray ABS
SE-268	300	230	86	IP-65	Dark Gray ABS
SE-270	300	230	111	IP-65	Dark Gray ABS
SE-272	360	200	150	IP-65	Dark Gray ABS
SE-2260	313	228	94	IP-65	Dark Gray ABS



IP-65 FLANGED PLASTIC ENCLOSURES

- IP-65 protection class, sealed waterproof enclosure
- ABS material
- TPE continuous seal
- Lid screws and wall mounting holes are outside sealed area to satisfy IP-65 protection to dust, liquid and moisture
- With brass inserts you can open and close the enclosure thousands of times
- M4 stainless cover screws
- RoHS compliant

	CODE	W	L	H	PROTECTION CLASS	DESCRIPTION
	SF - 202	84	50	39	IP-65	Dark Gray ABS
NEW	SF - 204	100	58	38,5	IP-67	Dark Gray ABS
	SF - 206	118	82	66	IP-65	Dark Gray ABS
NEW	SF - 207	118	82	55	IP-67	Dark Gray ABS
	SF - 212	154	65	59	IP-65	Dark Gray ABS
	SF - 214	158	80	59	IP-65	Dark Gray ABS
	SF - 220	142	100	100	IP-65	Dark Gray ABS
NEW	SF - 222	157,5	90	58,5	IP-67	Dark Gray ABS
	SF - 230	160	120	65	IP-65	Dark Gray ABS
	SF - 235	520	80	58	IP-65	Dark Gray ABS
	SF - 232	160	120	95	IP-65	Dark Gray ABS
	SF - 236	212	123	60	IP-65	Dark Gray ABS
	SF - 238	212	123	85	IP-65	Dark Gray ABS
	SF - 246	160	160	90	IP-65	Dark Gray ABS
	SF - 256	262	146	55	IP-65	Dark Gray ABS
	SF - 258	262	146	75	IP-65	Dark Gray ABS

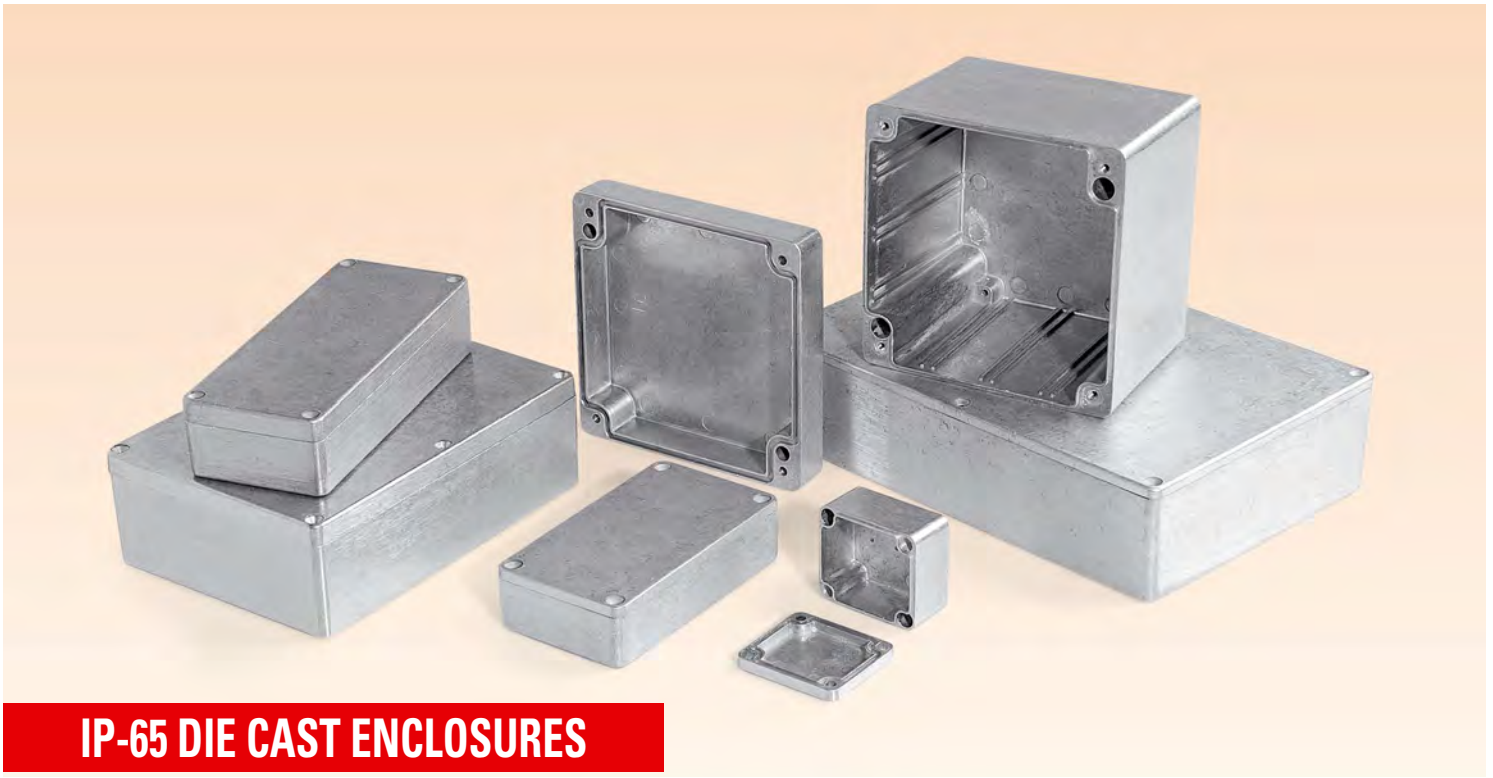

IP-65 DIE CAST ENCLOSURES

- Aluminium injection enclosures in standard sizes
- ADC-12 aluminium alloy
- Lid screws and wall mounting holes are outside sealed area to satisfy IP-65 protection to dust, liquid and moisture
- Included neopren seal enables IP-65 protection class
- Natural aluminium color can be painted
- Stainless cover screws
- RoHS compliant

CODE	W	L	H	PROTECTION CLASS	DESCRIPTION
SE-301	50	45	30	IP-65	IP-65 Sealed Enclosure
SE-303	90	36	30	IP-65	IP-65 Sealed Enclosure
SE-305	64	58	35	IP-65	IP-65 Sealed Enclosure
SE-307	98	64	34	IP-65	IP-65 Sealed Enclosure
SE-309	115	65	30	IP-65	IP-65 Sealed Enclosure
SE-311	115	65	55	IP-65	IP-65 Sealed Enclosure
SE-313	150	63	36,5	IP-65	IP-65 Sealed Enclosure
SE-315	125	80	40	IP-65	IP-65 Sealed Enclosure
SE-317	125	80	57	IP-65	IP-65 Sealed Enclosure
SE-319	115	90	55	IP-65	IP-65 Sealed Enclosure
SE-321	120,5	120,5	101,5	IP-65	IP-65 Sealed Enclosure
SE-323	148	108	75	IP-65	IP-65 Sealed Enclosure
SE-325	160	100	60	IP-65	IP-65 Sealed Enclosure
SE-327	160	100	81	IP-65	IP-65 Sealed Enclosure
SE-329	171	121	55	IP-65	IP-65 Sealed Enclosure
SE-331	158,5	158,5	101,5	IP-65	IP-65 Sealed Enclosure
SE-333	222	146	55	IP-65	IP-65 Sealed Enclosure
SE-335	222	146	82	IP-65	IP-65 Sealed Enclosure



DIE CAST ENCLOSURES

- Aluminium injection enclosures in standard sizes
- ADC-12 aluminium alloy
- Optional neoprene seal enables IP-65 protection class
- Natural aluminium color can be painted
- Includes 4 M 3.5 stainless screws
- RoHS compliant

CODE	W	L	H	PROTECTION CLASS	DESCRIPTION
SE-401	89	35	30		
SE-401-C	89	35	30	IP-65	With Gasket
SE-402	60	55	30		
SE-402-C	60	55	30	IP-65	With Gasket
SE-403	80	55	25		
SE-403-C	80	55	25	IP-65	With Gasket
SE-404	114	64	30		
SE-404-C	114	64	30	IP-65	With Gasket
SE-405	114	64	55		
SE-405-C	114	64	55	IP-65	With Gasket
SE-406	114	89	55		
SE-406-C	114	89	55	IP-65	With Gasket
SE-407	120	100	35		
SE-407-C	120	100	35	IP-65	With Gasket
SE-408	140	100	75		
SE-408-C	140	100	75	IP-65	With Gasket

CODE	W	L	H	PROTECTION CLASS	DESCRIPTION
SE-409	171	121	55		
SE-409-C	171	121	55	IP-65	With Gasket
SE-410	171	121	106		
SE-410-C	171	121	106	IP-65	With Gasket
SE-411	165	127	75		
SE-411-C	165	127	75	IP-65	With Gasket
SE-412	222	146	55		
SE-412-C	222	146	55	IP-65	With Gasket
SE-413	222	146	106		
SE-413-C	222	146	106	IP-65	With Gasket
SE-414	275	175	65		
SE-414-C	275	175	65	IP-65	With Gasket
SE-415	250	250	100		
SE-415-C	250	250	100	IP-65	With Gasket

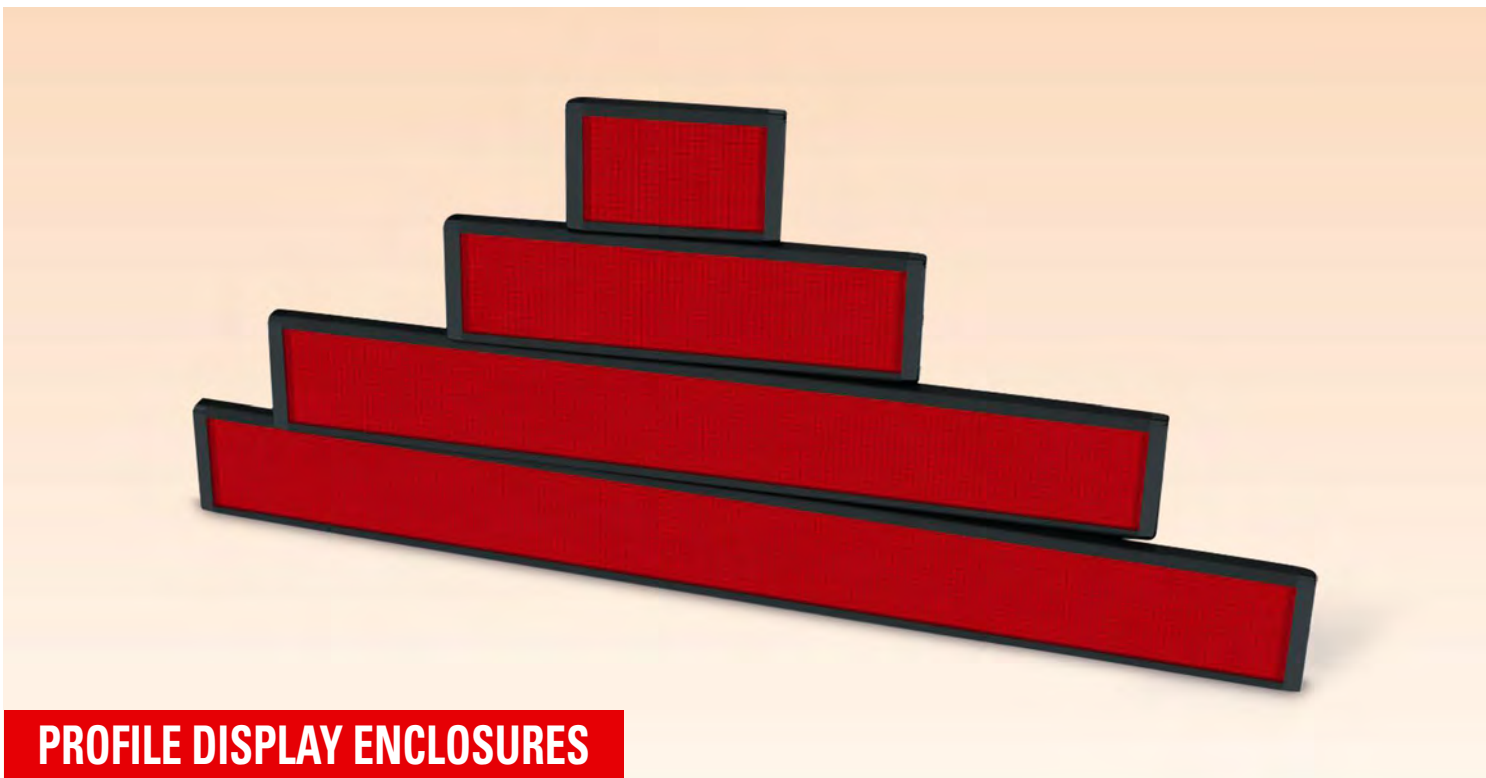

PROFILE DISPLAY ENCLOSURES

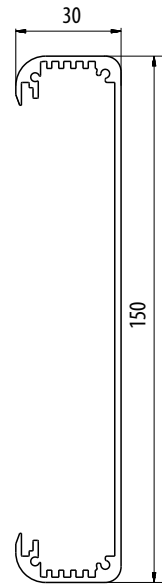
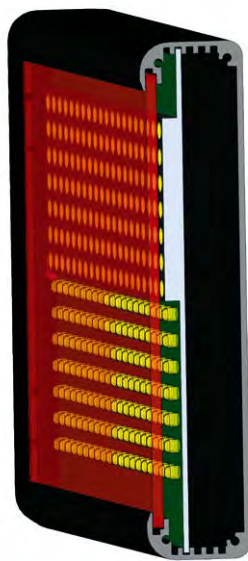
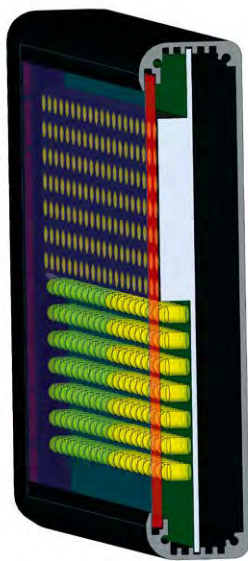

CARD RAILS FOR DIFFERENT TYPES OF LEDS AND 7-SEGMENT DISPLAYS

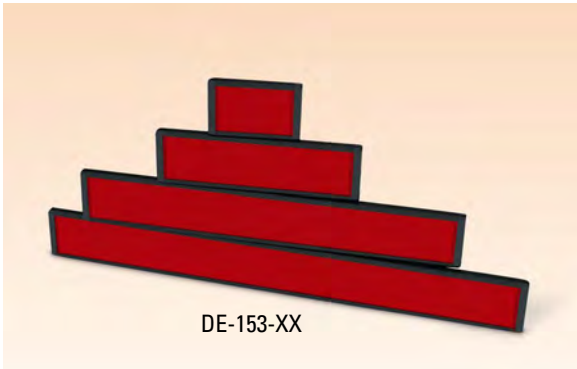

DE-153-XX

DE-153-XX 150 x 30 x (CUSTOM)mm **ALUMINIUM PROFILE ENCLOSURES**

MATERIAL	ALUMINIUM 6063
COLOR	BLACK/WHITE
SURFACE	MATTE ELECTROSTATIC PAINT
PLASTIC END CAPS	BLACK

* DE-153-XX Length can be customized between 40mm to 3m

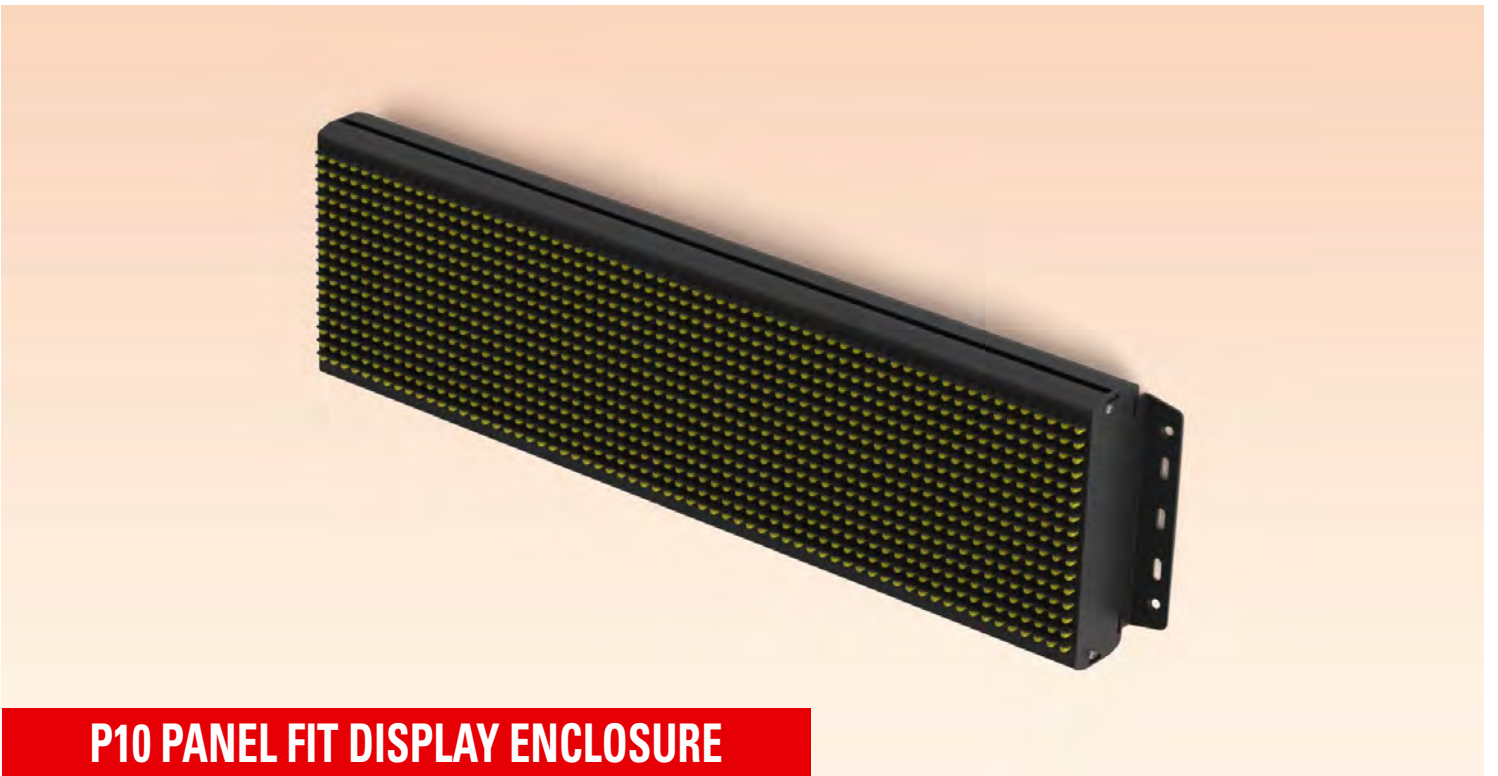

P10 PANEL FIT DISPLAY ENCLOSURE

- Designed for P10 led modules
- Very fast mounting advantage
- Durable structure
- Stainless end cap screws

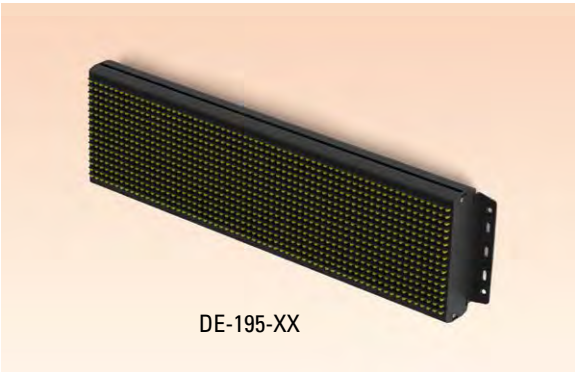
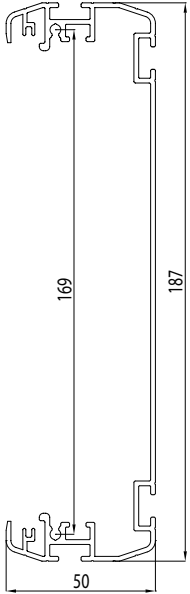

DE-195-XX 187 x 50 x (CUSTOM) mm **P10 PANEL FIT DISPLAY ENCLOSURE**

MATERIAL	ALUMINIUM 6063
COLOR	BLACK
SURFACE	ELECTROSTATIC PAINT
END CAPS	2,5 mm ALUMINIUM FLANGED END CAPS FLAT END CAPS

* DE-195-XX Length can be customized between 40mm to 3m



MODULAR DISPLAY ENCLOSURES

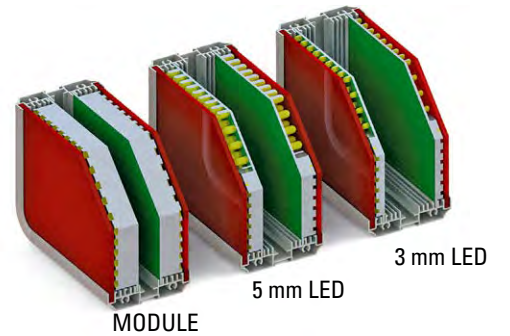
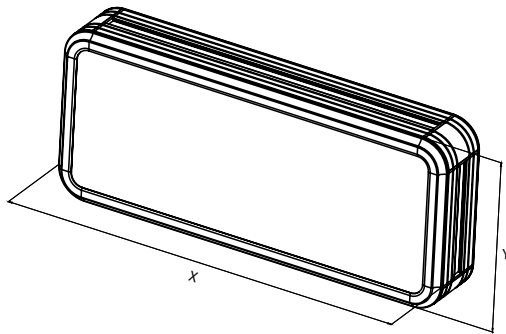

DE-060-X-Y

X-Y-6 cm

MODULAR DISPLAY ENCLOSURE

PANEL OPTIONS

RED SATIN (Glossy+Frosted)
RED GLOSSY (Glossy+ Glossy)
SMOKED GLOSSY

MATERIAL	ALUMINIUM 6063
COLOR	BLACK / WHITE / NATURAL ANODIZED
SURFACE	ELECTROSTATIC PAINT / ANODIZED

* DE-060-X-Y LENGTH CAN BE CUSTOMIZED BETWEEN 10 cm AND 2 m.

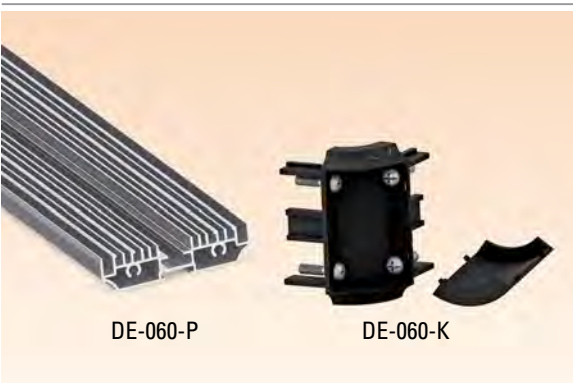

DE-060-P-X

PROFILE
6 x 1,5 x X cm

MODULAR DISPLAY ENCLOSURE

DE-060-K

BRACKET SET

DE-060-L

METAL CORNER

DE-060-P PROFILE

MATERIAL	ALUMINIUM 6063
COLOR	BLACK / WHITE / NATURAL ANODIZED

DE-060-K BRACKET SET

MATERIAL	ABS
COLOR	BLACK / WHITE
SCREWS	4 PCS/BOX M4 x 16 COMBO HEAD STAINLESS

* DE-060-X-Y LENGTH CAN BE CUSTOMIZED BETWEEN 4 cm AND 3 m.

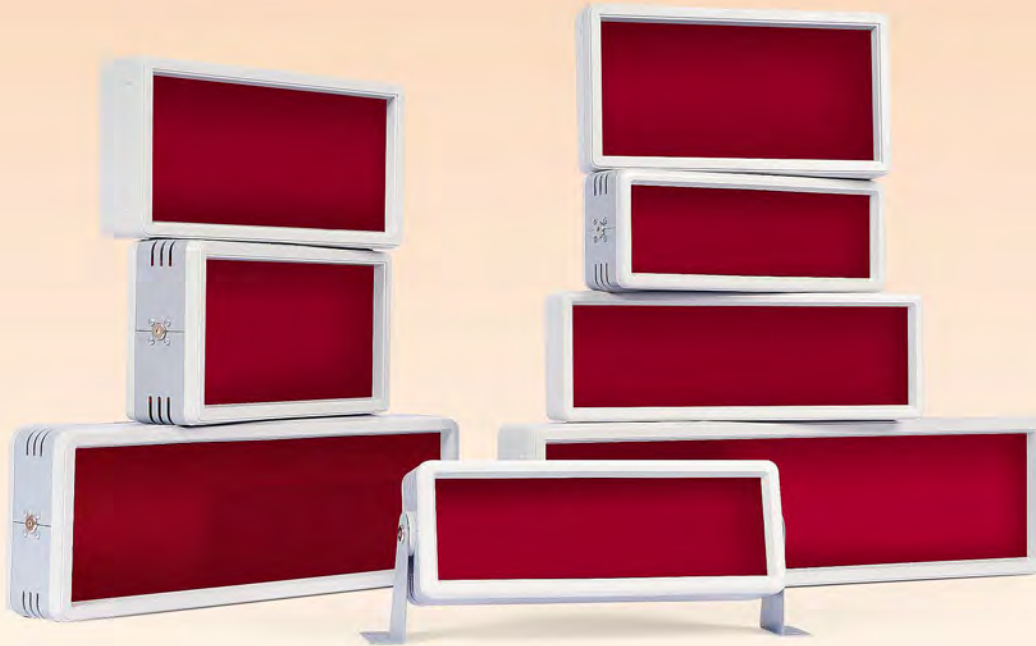

DISPLAY ENCLOSURES



MOUNTING KIT

A-954

25 x 50 x 97 mm

ANGLED MOUNTING KIT

COLOR DARK GRAY / BLACK

SUITABLE ENCLOSURES

DE-120

DE-130

DE-150

DE-153

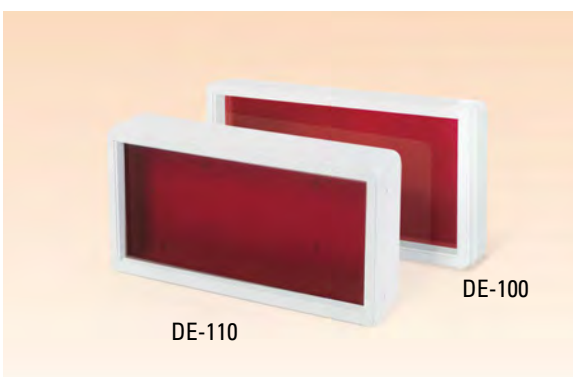

DE-110

DE-100

DE-100

288 x 150 x 36 mm

DISPLAY ENCLOSURE

DE-110

288 x 150 x 56 mm

PANEL OPTIONS

RED SATIN / GLOSSY RED / GRAY

SUITABLE ACCESSORIES

A-58 CLICK WALL MOUNT

MATERIAL

BODY ABS

PANEL PLEXIGLAS

COLOR GRAY / BLACK

PACKAGING 1 PCS/BOX

DE-115

350 x 115 x 50 mm

DISPLAY ENCLOSURE

MATERIAL

BODY ABS

PANEL PLEXIGLAS

COLOR GRAY / BLACK

PACKAGING 10 PCS/BOX

PANEL OPTIONS

RED SATIN (Glossy + Frosted)

RED GLOSSY (Glossy + Glossy)

DE-115

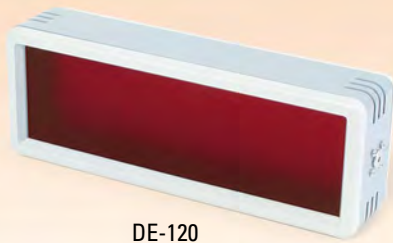

DE-120

DE-120

DOUBLE SIDED
288 x 103 x 68 mm

DISPLAY ENCLOSURE

MATERIAL	
BODY	ALUMINIUM
FRAME	ABS
COLOR	GRAY
PANEL	PLEXIGLAS
PACKAGING	10 PCS/BOX

PANEL OPTIONS

RED SATIN / GLOSSY RED



DE-130

DE-130

DOUBLE SIDED
288 x 150 x 73 mm

DISPLAY ENCLOSURE

MATERIAL	
BODY	ALUMINIUM
FRAME	ABS
COLOR	GRAY
PANEL	PLEXIGLAS
PACKAGING	10 PCS/BOX

PANEL OPTIONS

RED SATIN / GLOSSY RED

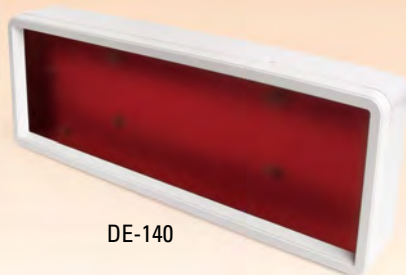

DE-140

DE-140

430 x 150 x 60 mm

DISPLAY ENCLOSURE

MATERIAL	
BODY	ABS
COLOR	GRAY / BLACK
PANEL	PLEXIGLAS
PACKAGING	10 PCS/BOX

SUITABLE ACCESSORIES

A-58 CLICK WALL MOUNT

PANEL OPTIONS

RED SATIN / GLOSSY RED

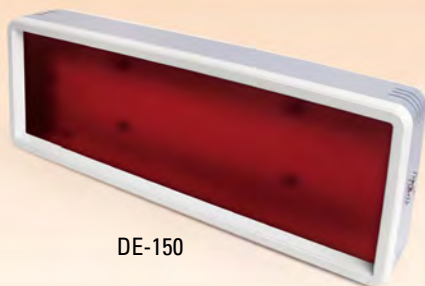

DE-150

DE-150

DOUBLE SIDED
430 x 150 x 74 mm

DISPLAY ENCLOSURE

MATERIAL	
BODY	ALUMINIUM
FRAME	ABS
COLOR	GRAY
PANEL	PLEXIGLAS
PACKAGING	10 PCS/BOX

SUITABLE ACCESSORIES

A-58 CLICK WALL MOUNT

PANEL OPTIONS

RED SATIN / GLOSSY RED



DE-170

DE-170

570 x 150 x 60 mm

DISPLAY ENCLOSURE

MATERIAL	
BODY	ABS
COLOR	GRAY / BLACK
PANEL	PLEXIGLAS
PACKAGING	10 PCS/BOX

PANEL OPTIONS

RED SATIN (Glossy+Frosted)

RED GLOSSY (Glossy+ Glossy)

SUITABLE ACCESSORIES

A-58 CLICK WALL MOUNT



PLASTIC CASES



PC-460

PC-460

337 x 275 x 83 mm

PLASTIC CASES

MATERIAL	PP
COLOR	RED / BLACK / BLUE
PACKAGING	12 PCS/BOX



PC-470

PC-470

337 x 275 x 124 mm

PLASTIC CASES

MATERIAL	PP
COLOR	RED / BLACK / BLUE
PACKAGING	8 PCS/BOX



PC-480

PC-480

337 x 275 x 165 mm

PLASTIC CASES

MATERIAL	PP
COLOR	RED / BLACK / BLUE
PACKAGING	6 PCS/BOX

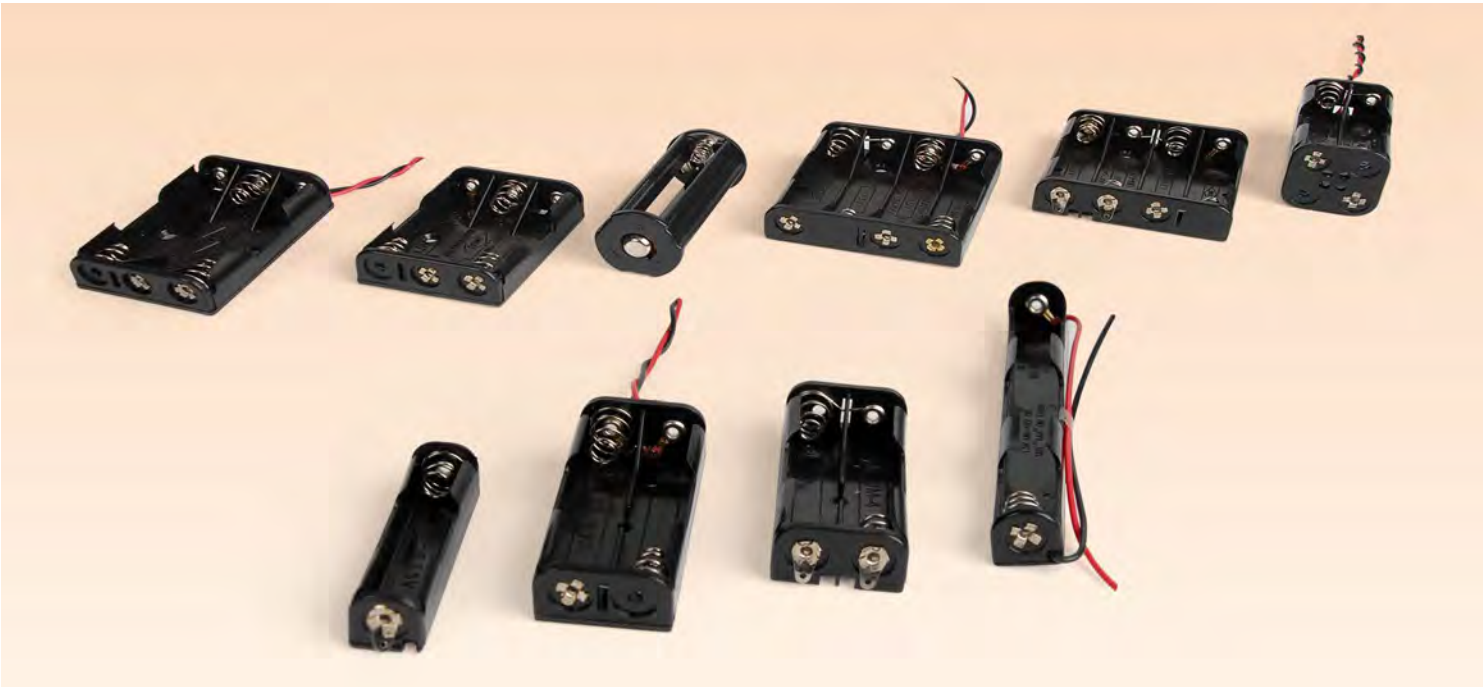

BATTERY HOLDERS

BC-0301

AA SIZE APPLICABLE PCB CONTACT

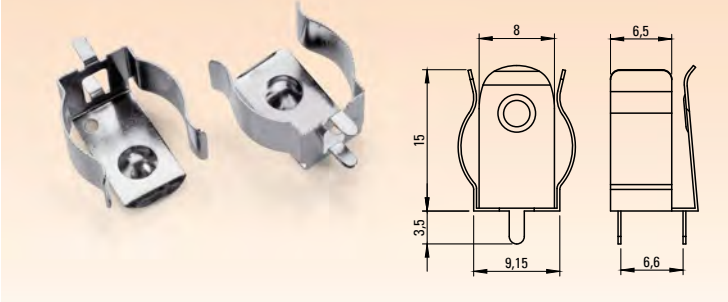

BH-311-1D

1 X AA SIZE BATTERY HOLDER

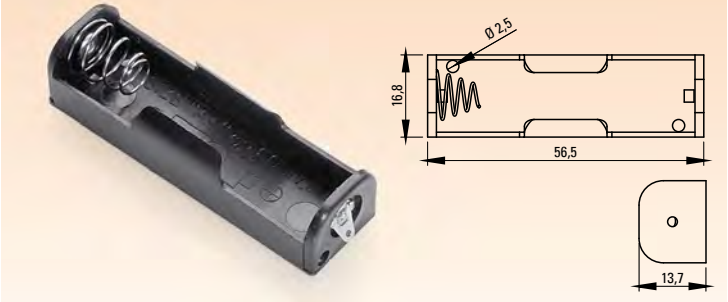

BH-311-1P24

1 X AA SIZE BATTERY HOLDER

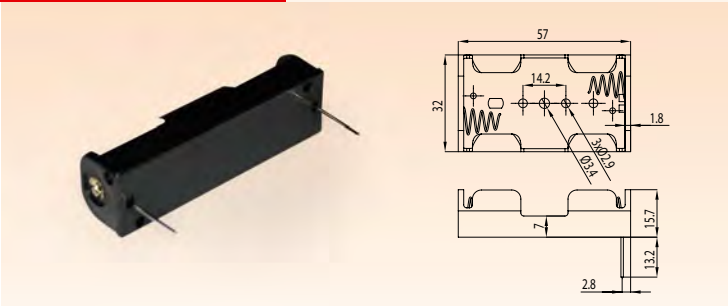

BH-321-1A

2 X AA SIZE BATTERY HOLDER

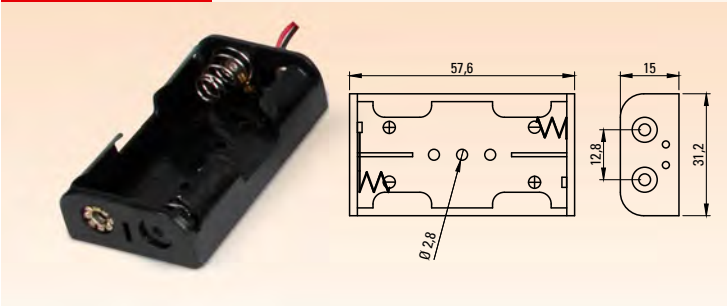

BH-321-1P24

2 X AA SIZE BATTERY HOLDER

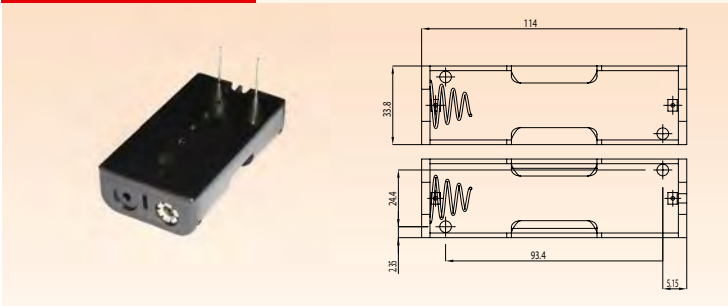

BH-325-1A

2 X AA SIZE BATTERY HOLDER

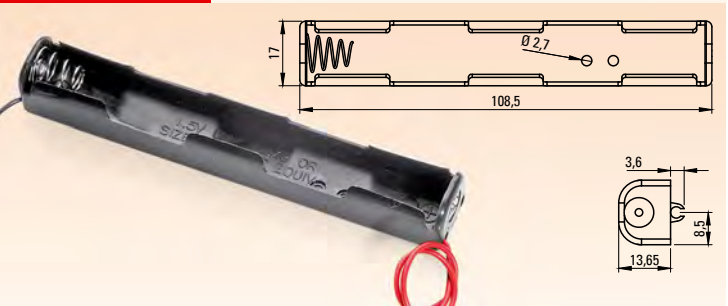

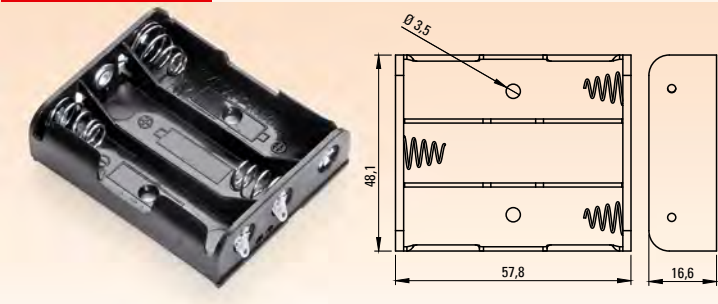
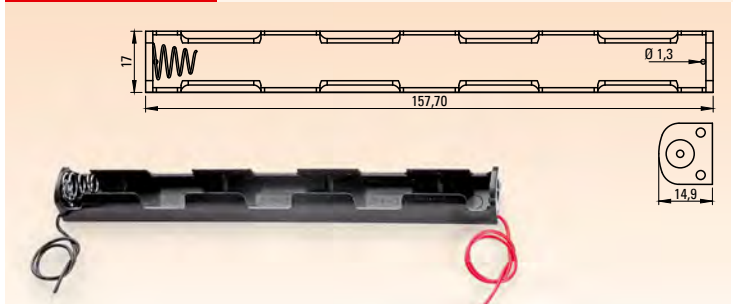
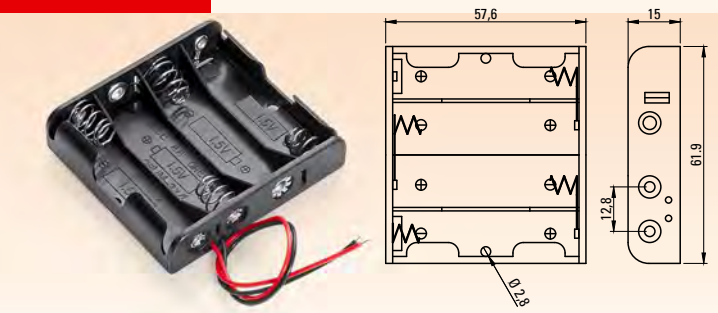
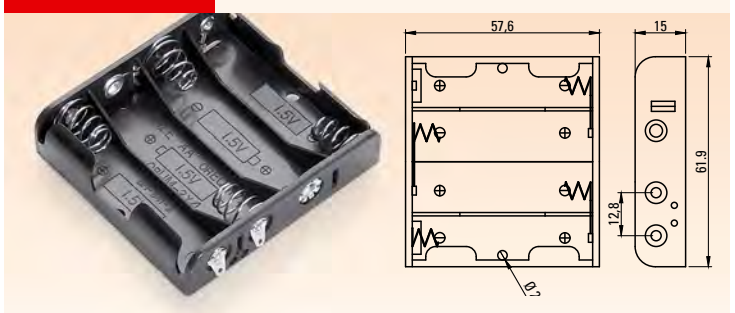
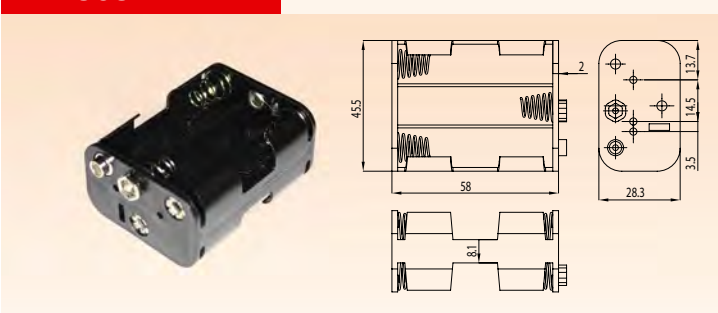
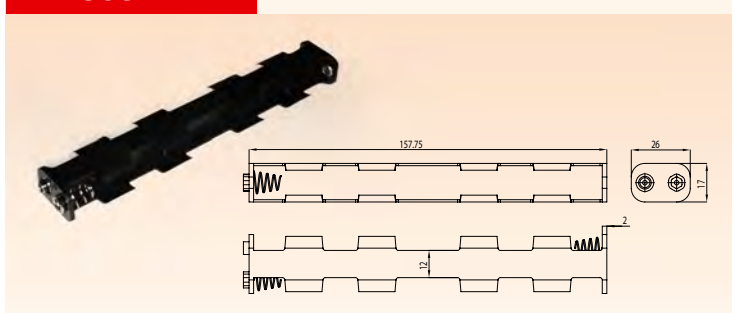
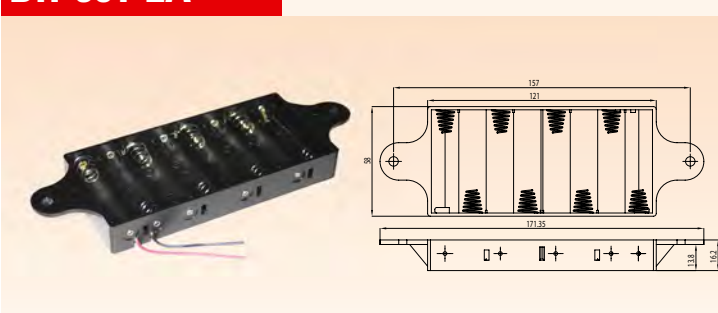
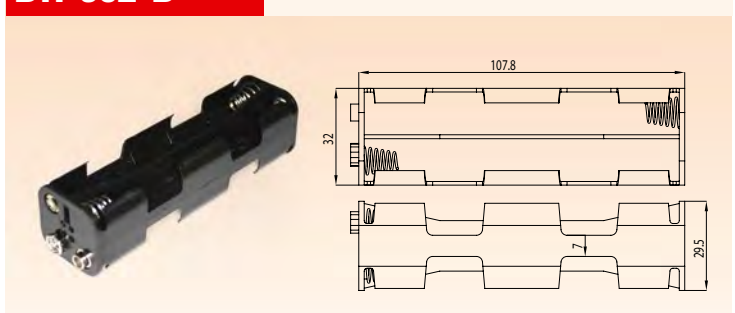
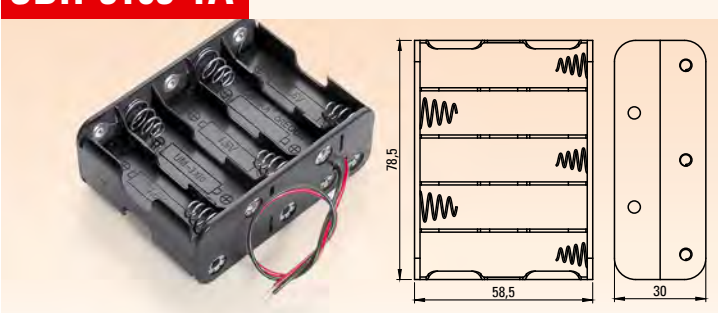
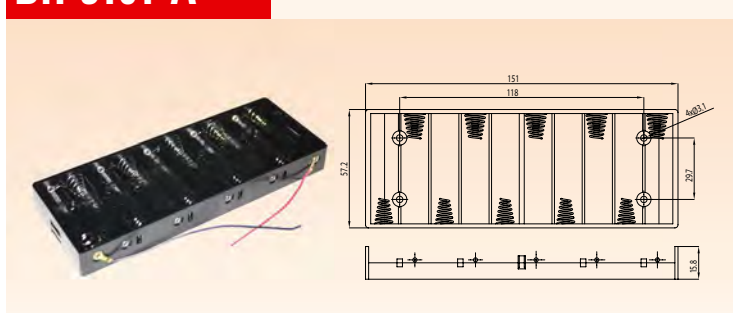
BH-331-1D**3 X AA SIZE BATTERY HOLDER****BH-333-A****4 X AA SIZE BATTERY HOLDER****BH-341-2A****4 X AA SIZE BATTERY HOLDER****BH-341-2D****4 X AA SIZE BATTERY HOLDER****BH-363-B****6 X AA SIZE BATTERY HOLDER****BH-365-B****6 X AA SIZE BATTERY HOLDER****BH-381-2A****8 X AA SIZE BATTERY HOLDER****BH-382-B****8 X AA SIZE BATTERY HOLDER****SBH-3103-1A****10 X AA SIZE BATTERY HOLDER****BH-3101-A****10 X AA SIZE BATTERY HOLDER**

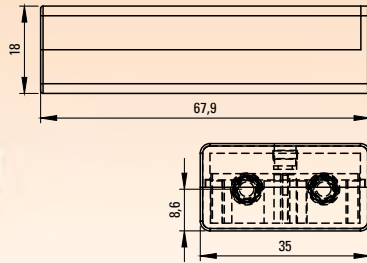
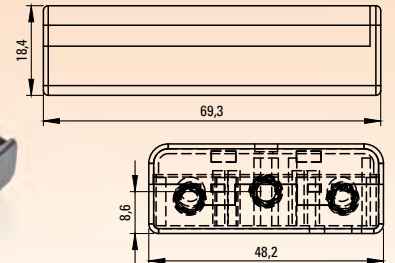
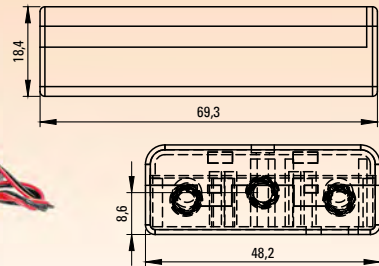
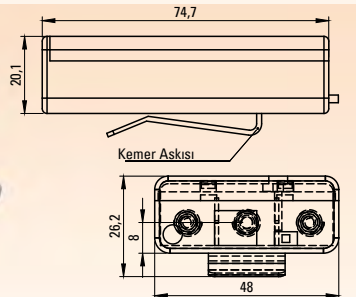
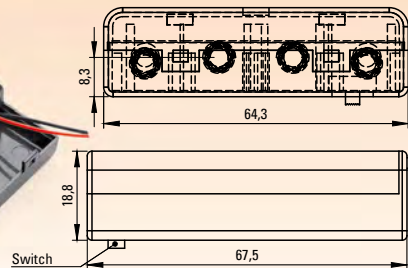
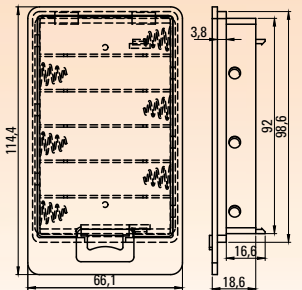
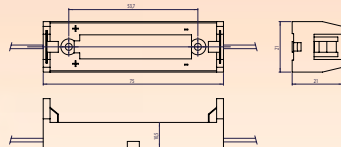
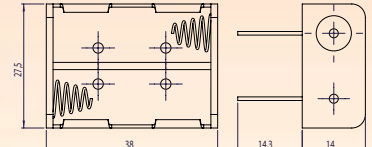
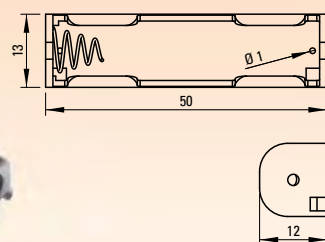
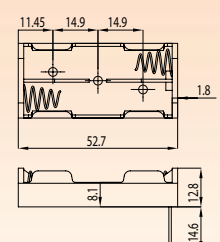
SBH-321-2A**2 X AA SIZE BATTERY HOLDER****SBH-331-1A****2 X AA SIZE BATTERY HOLDER****SBH-331-AS****3 X AA SIZE BATTERY HOLDER****SBH-331-1AS****3 X AA SIZE BATTERY HOLDER****SBH-341-1AS****4 X AA SIZE BATTERY HOLDER****SBH-361-1A****6 X AA SIZE BATTERY HOLDER****BHC-18650-1A****1 X 18650 LI-ION BATTERY HOLDER****BH-521-P****2 X 23 A SIZE BATTERY HOLDER****BH-411-1D****1 X AAA SIZE BATTERY HOLDER****BH-421-P24****2 X AAA SIZE BATTERY HOLDER**

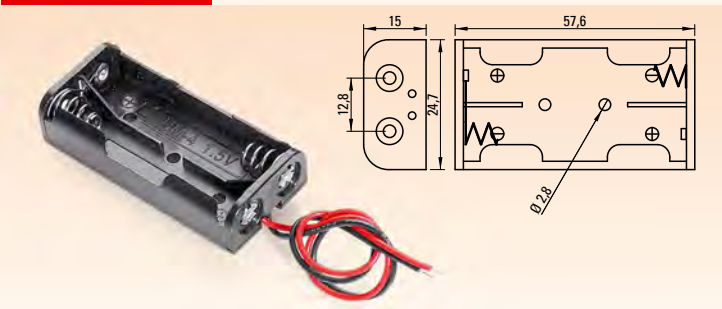
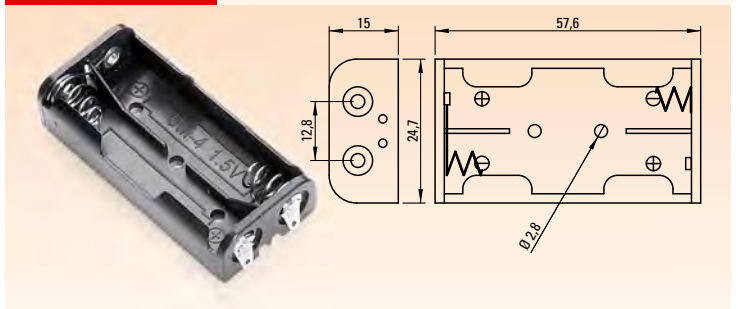
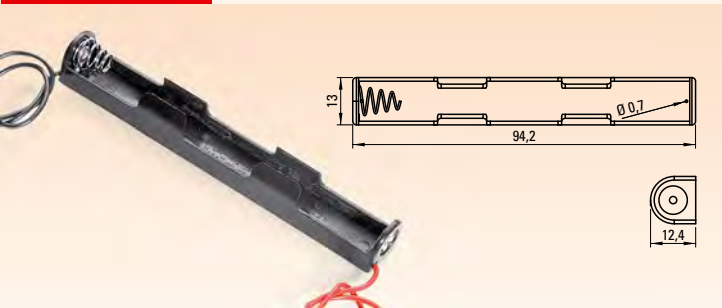
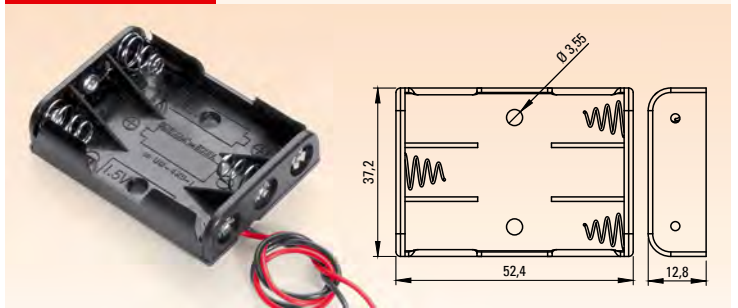
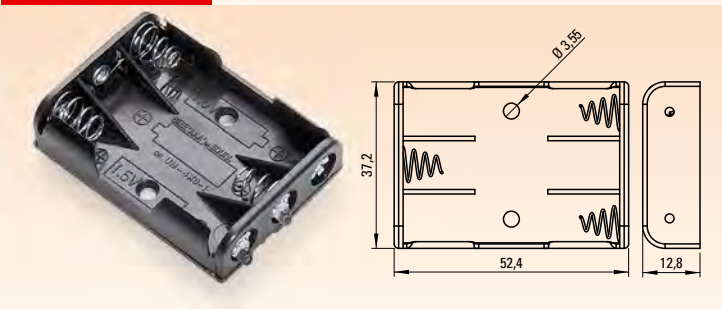
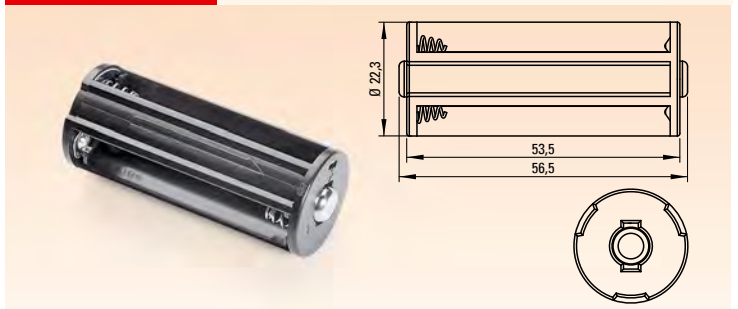
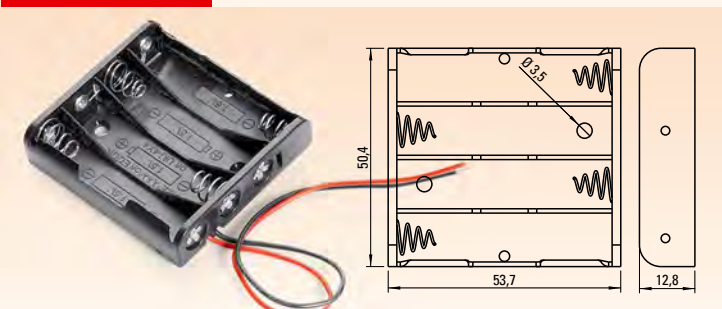
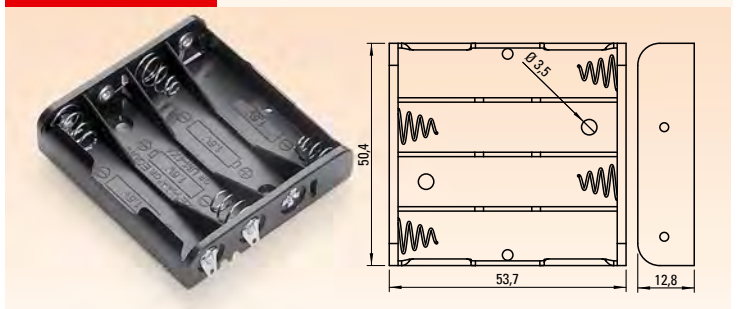
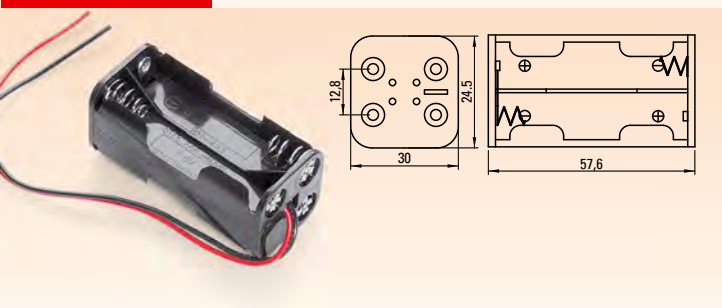
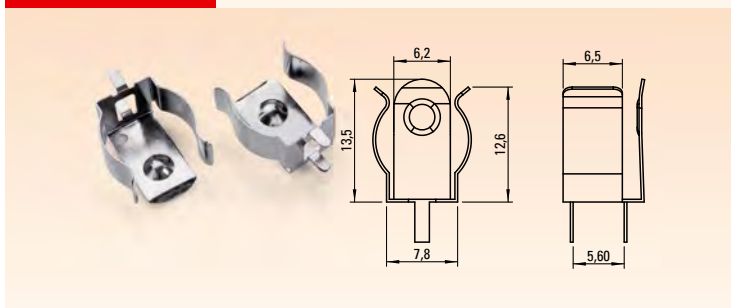
BH-421-A**2 X AAA SIZE BATTERY HOLDER****BH-421-D****2 X AAA SIZE BATTERY HOLDER****BH-425-A****2 X AAA SIZE BATTERY HOLDER****BH-431-1A****3 X AAA SIZE BATTERY HOLDER****BH-431-1D****3 X AAA SIZE BATTERY HOLDER****BH-432-A****3 X AAA SIZE BATTERY HOLDER****BH-441-A****4 X AAA SIZE BATTERY HOLDER****BH-441-D****4 X AAA SIZE BATTERY HOLDER****BH-443-A****4 X AAA SIZE BATTERY HOLDER****BC-0401****AAA & 23A SIZE APPLICABLE PCB CONTACT**

BC-401**AA SIZE BATTERY CONTACT**

BC-401-AC



BC-401-C

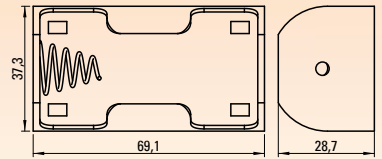
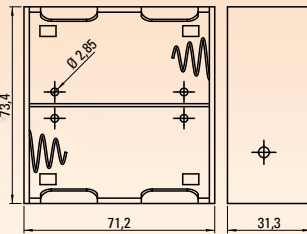
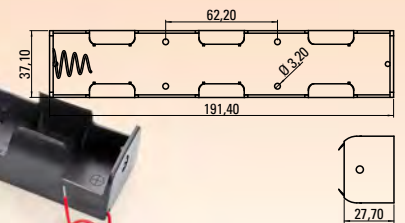
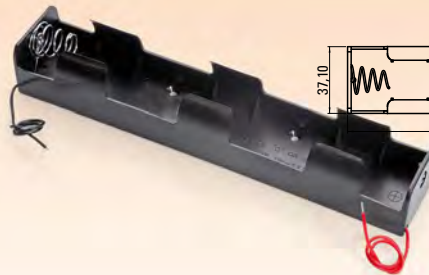
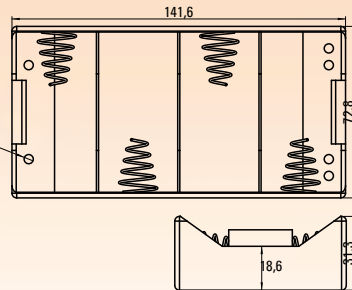
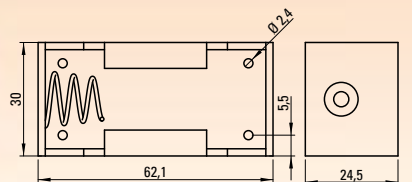
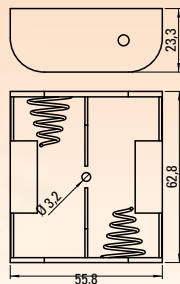
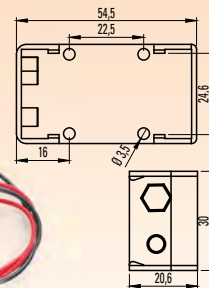
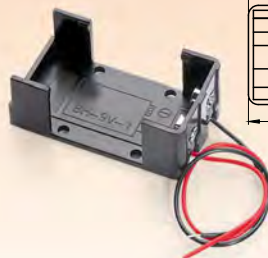
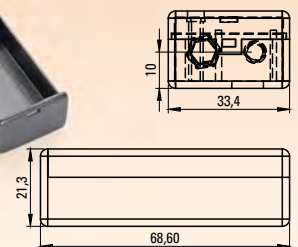
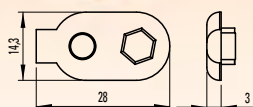
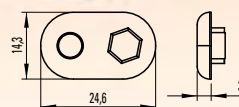

BC-401-A

BH-111-A**1 X D SIZE BATTERY HOLDER****BH-121-1A****2 X D SIZE BATTERY HOLDER****BH-132-A****3 X D SIZE BATTERY HOLDER****BH-143-1A****4 X D SIZE BATTERY HOLDER****BH-211-A****1 X C SIZE BATTERY HOLDER****BH-221-A****2 X C SIZE BATTERY HOLDER****BH-9V-1A****1 X 9V BATTERY HOLDER****SBH-9V-A****1 X 9V CAPPED BATTERY HOLDER****BS-ICCT****9V BATTERY CONTACT****BS-ECCT****9V BATTERY CONTACT**

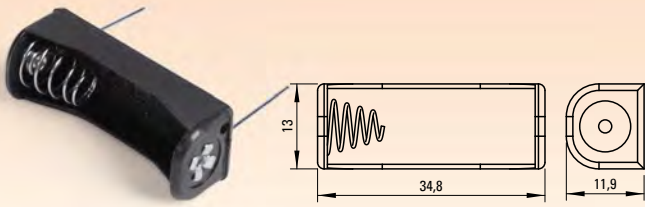
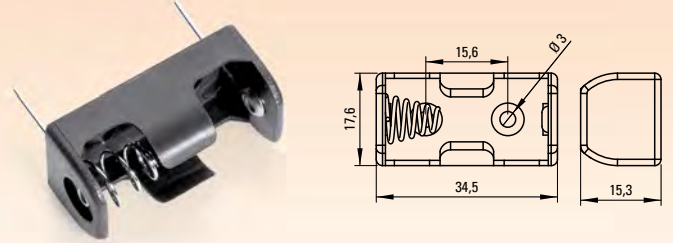
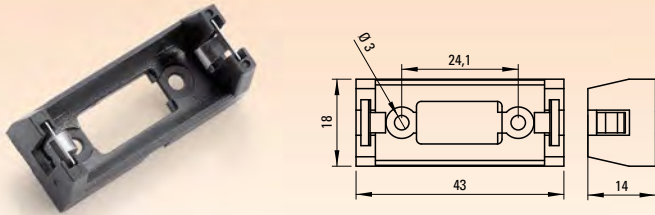
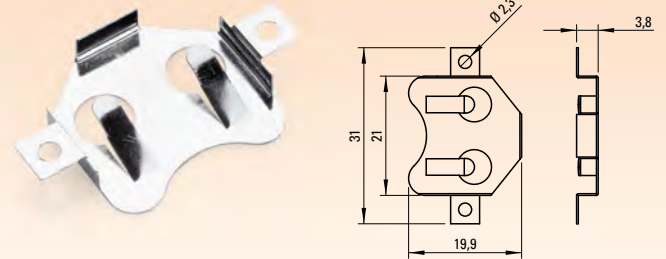
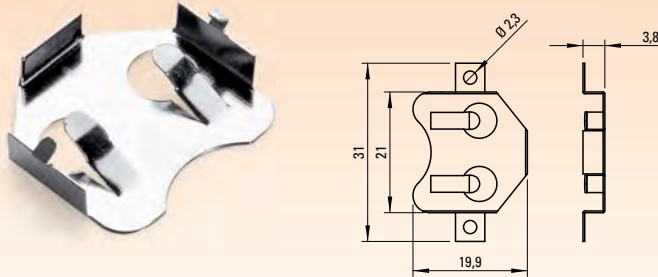
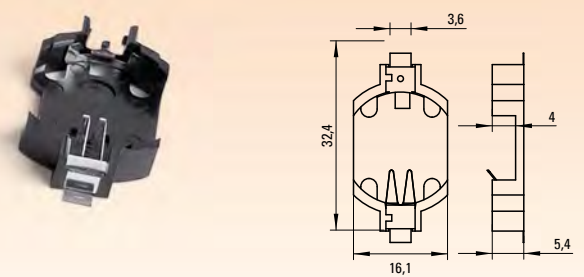
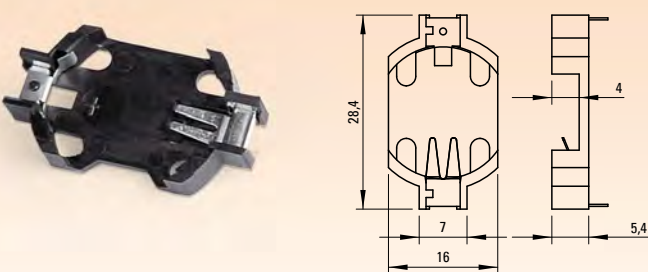
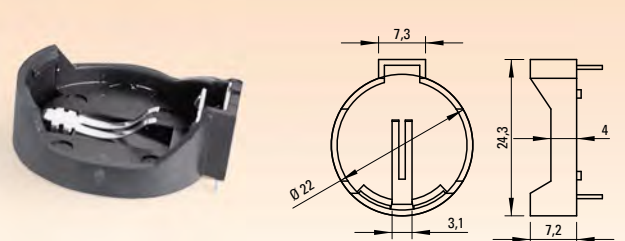
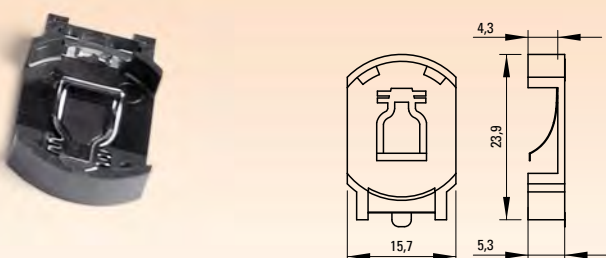
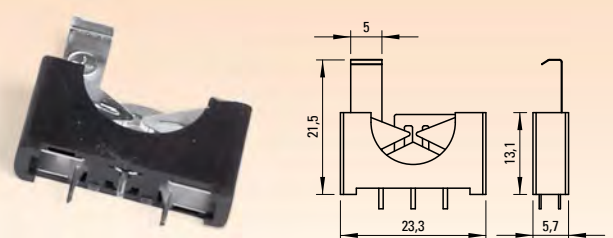
BH-511-P**1 X 23 A SIZE BATTERY HOLDER****BH-1/2AA-2P24****1 X 1/2 AA SIZE BATTERY HOLDER****BHC-CR123A****1 X CR123A SIZE BATTERY HOLDER****BC-2001****CR-2032 BATTERY HOLDER****BC-2002****CR-2032 CELL HOLDER****CH-004-2032****CR-2032 BATTERY HOLDER****CH-005-2032****CR-2032 CELL HOLDER****CH-224-2032****CR-2032 CELL HOLDER****CH-7410-2032****CR-2032 CELL HOLDER****CH-243-2032****CR-2032 CELL HOLDER**

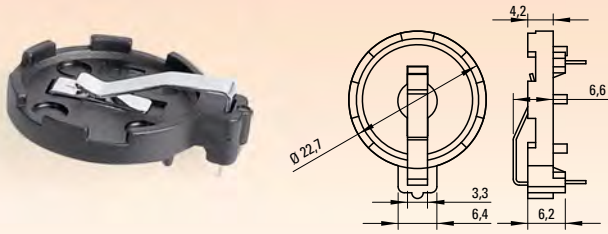
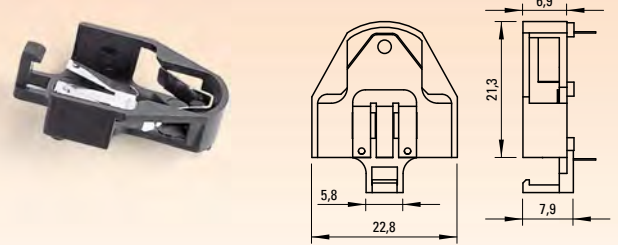
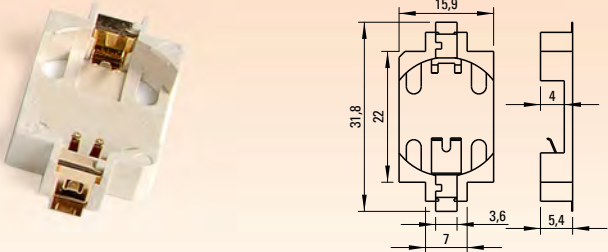
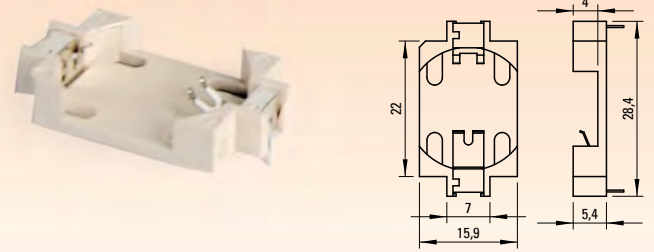
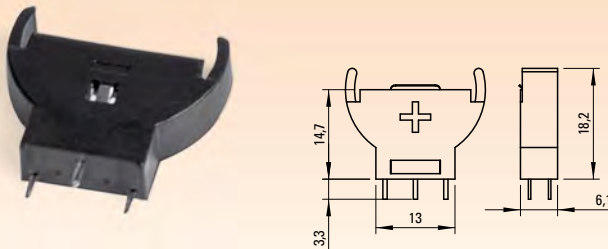
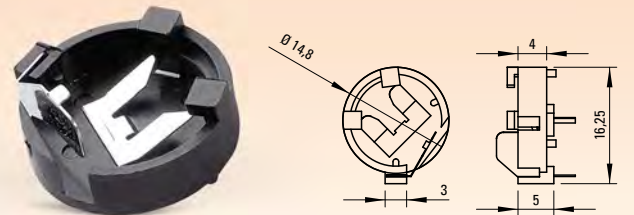
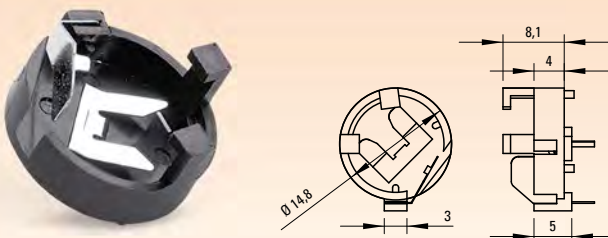
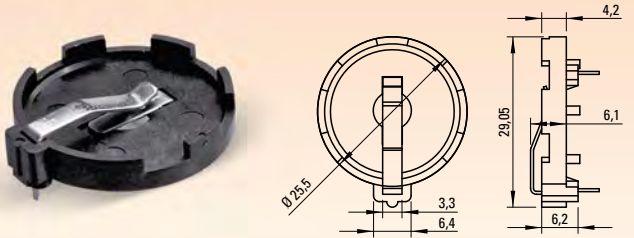
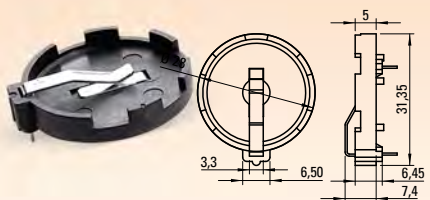
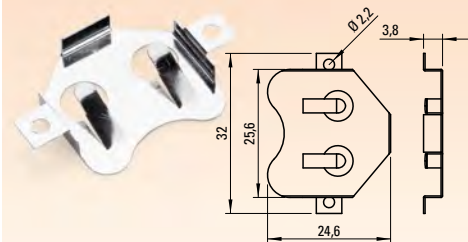
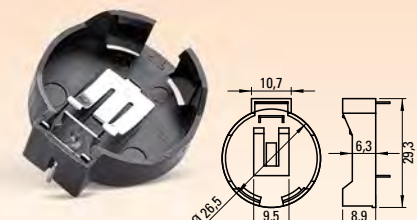
CH-25-2032**CR-2032 CELL HOLDER****CH-26-2032****CR-2032 CELL HOLDER****CH-28-2032****CR-2032 CELL HOLDER****CH-29-2032****CR-2032 CELL HOLDER****CH-74-2032****CR-2032 CELL HOLDER****CH-23-1220****CR-2032 CELL HOLDER****CH-23-1225****CR-1225 CELL HOLDER****CH-25-2325****CR-2325 CELL HOLDER****CH-002-2425****CR-2425 CELL HOLDER****BC-2401****CR-2430 CELL HOLDER****CH-273-2450****CR-2450 CELL HOLDER**

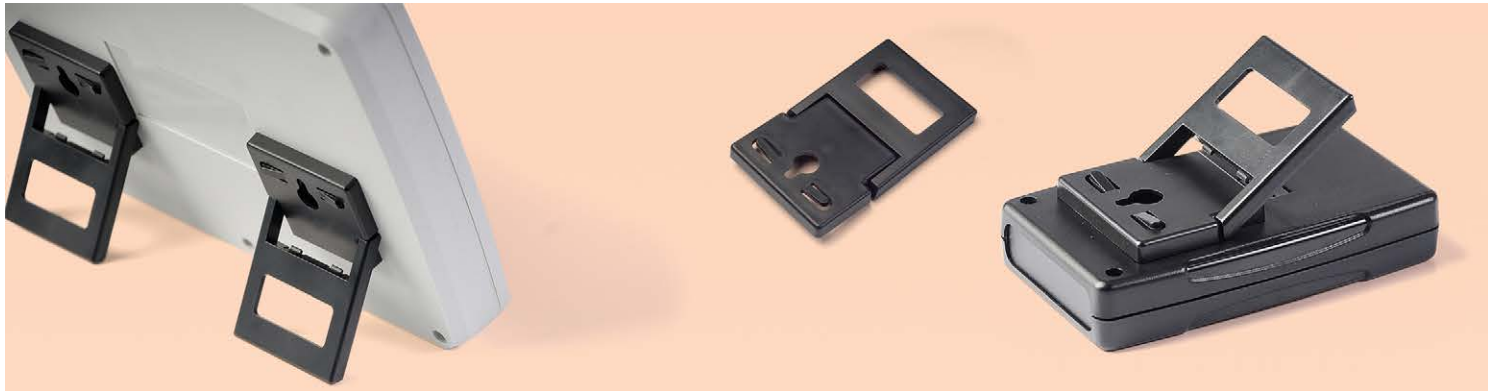

ALTINKAYA

ACCESSORIES

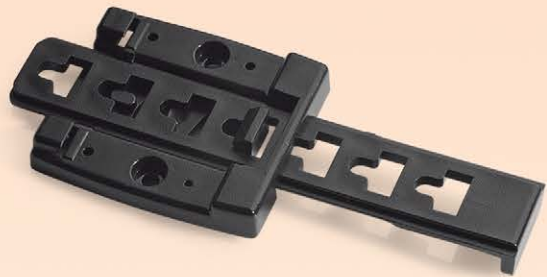

STANDARD PLASTIC CABLE GLANDS (METRIC)

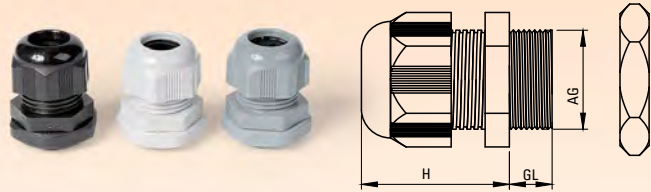

STANDARD PLASTIC CABLE GLANDS (PG)

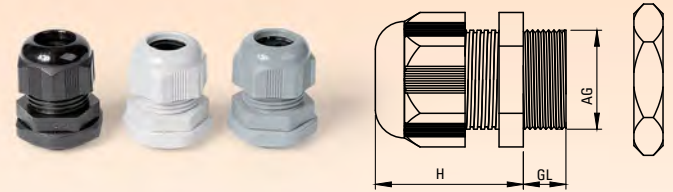

Metric	Code	Pcs in Bag	H (mm)	GL (mm)	Spanner Size (mm)	Fitting Dia (mm)	Cable Dia (mm)
M12x1,5	OMR 01	10	24	8	15	12,5	3-6,5
M16x1,5	OMR 02	10	28	8	19	16,5	4-8
M16x1,5	OMR 03	10	29	10	22	16,5	5-10
M20x1,5	OMR 04	10	29	10	24	20,5	6-12
M20x1,5	OMR 05	10	33	10	27	20,5	10-14
M25x1,5	OMR 06	10	38	10	33	25,5	13-18
M32x1,5	OMR 07	5	41	10	42	32,5	18-25
M40x1,5	OMR 08	5	51	10	53	40,5	22-32
M50x1,5	OMR 09	3	53	18	60	50,5	30-38
M63x1,5	OMR 10	2	55	18	65	63,5	34-44

PG	Code	Pcs in Bag	H (mm)	GL (mm)	Spanner Size (mm)	Fitting Dia (mm)	Cable Dia (mm)
PG7	OR 01	10	24	8	15	13	3-6,5
PG9	OR 02	10	28	8	19	16	4-8
PG11	OR 03	10	29	8	22	19	5-10
PG13,5	OR 04	10	29	9	24	21	6-12
PG16	OR 05	10	33	9	27	23	10-14
PG21	OR 06	10	38	11	33	29	13-18
PG29	OR 07	5	41	11	42	37,5	18-25
PG36	OR 08	5	51	13	53	47,5	22-32
PG42	OR 09	3	53	13	60	54,5	30-38
PG48	ORG10	2	55	14	65	60	34-44

MULTI-HOLE CABLE GLAND SEALS



CODE	Holes	Hole Dia (mm)	Compatible PG Size Gland	Compatible Metric Size Gland	Compatible Spiral PG Size Gland	Compatible Spiral Metric Size Gland	Compatible PG Size Brass Gland	Compatible Metric Size Brass Gland
MEC02A3	2	3	OR 02 (PG9)	OMR 02 (M16x1,5)	OR 20 (PG9)	OMR 18 (M16x1,5)	OPB 02 (PG9)	OMB 02 (M16x1,5)
MEC03A3	3	3	OR 02 (PG9)	OMR 02 (M16x1,5)	OR 20 (PG9)	OMR 18 (M16x1,5)	OPB 02 (PG9)	OMB 02 (M16x1,5)
MEC02C3	4	3	OR 02 (PG9)	OMR 02 (M16x1,5)	OR 20 (PG9)	OMR 18 (M16x1,5)	OPB 02 (PG9)	OMB 02 (M16x1,5)
MEC03A4	2	4	OR 03 (PG11)	OMR 03 (M16x1,5)	OR 21 (PG11)	OMR 19 (M16x1,5)	OPB 03 (PG11)	-
MEC03A5	2	5	OR 03 (PG11)	OMR 03 (M16x1,5)	OR 21 (PG11)	OMR 19 (M16x1,5)	OPB 03 (PG11)	OMB 03 (M20x1,5)
MEC03B5	3	5	OR 03 (PG11)	OMR 03 (M16x1,5)	OR 21 (PG11)	OMR 19 (M16x1,5)	OPB 03 (PG11)	OMB 03 (M20x1,5)
MEC04A6	2	6	OR 04 (PG13,5)	OMR 04 (M20x1,5)	OR 22 (PG13,5)	OMR 20 (M20x1,5)	OPB 04 (PG13,5)	-
MEC04B5	3	5	OR 04 (PG13,5)	OMR 04 (M20x1,5)	OR 22 (PG13,5)	OMR 20 (M20x1,5)	OPB 04 (PG13,5)	-
MEC05A4	2	4	OR 05 (PG16)	OMR 05 (M20x1,5)	OR 23 (PG16)	OMR 21 (M20x1,5)	OPB 05 (PG16)	OMB 04 (M25x1,5)
MEC05A7	2	7	OR 05 (PG16)	OMR 05 (M20x1,5)	OR 23 (PG16)	OMR 21 (M20x1,5)	OPB 05 (PG16)	OMB 04 (M25x1,5)
MEC05B6	3	6	OR 05 (PG16)	OMR 05 (M20x1,5)	OR 23 (PG16)	OMR 21 (M20x1,5)	OPB 05 (PG16)	OMB 04 (M25x1,5)
MEC05C5	4	5	OR 05 (PG16)	OMR 05 (M20x1,5)	OR 23 (PG16)	OMR 21 (M20x1,5)	OPB 05 (PG16)	OMB 04 (M25x1,5)
MEC06A9	2	9	OR 06 (PG21)	OMR 06 (M25x1,5)	OR 24 (PG21)	OMR 22 (M25x1,5)	OPB 06 (PG21)	OMB 05 (M32x1,5)
MEC06B7	3	7	OR 06 (PG21)	OMR 06 (M25x1,5)	OR 24 (PG21)	OMR 22 (M25x1,5)	OPB 06 (PG21)	OMB 05 (M32x1,5)
MEC06B8	3	8	OR 06 (PG21)	OMR 06 (M25x1,5)	OR 24 (PG21)	OMR 22 (M25x1,5)	OPB 06 (PG21)	OMB 05 (M32x1,5)
MEC06C7	4	7	OR 06 (PG21)	OMR 06 (M25x1,5)	OR 24 (PG21)	OMR 22 (M25x1,5)	OPB 06 (PG21)	OMB 05 (M32x1,5)
MEC06G4	8	4	OR 06 (PG21)	OMR 06 (M25x1,5)	OR 24 (PG21)	OMR 22 (M25x1,5)	OPB 06 (PG21)	OMB 05 (M32x1,5)
MEC07C9	4	9	OR 07 (PG29)	OMR 07 (M32x1,5)	-	-	OPB 07 (PG29)	OMB 06 (M40x1,5)
MEC07D3	16	3	OR 07 (PG29)	OMR 07 (M32x1,5)	-	-	OPB 07 (PG29)	OMB 06 (M40x1,5)
MEC08E8	6	8	OR 08 (PG36)	OMR 08 (M40x1,5)	-	-	OPB 07 (PG29)	OMB 06 (M40x1,5)

NICKEL PLATED BRASS CABLE GLAND (METRIC)



Metric	Code	Pcs in Box	H (mm)	GL (mm)	Spanner Size (mm)	Fitting Dia (mm)	Cable Dia (mm)
M12x1,5	OMB 01	10	19	6	14-14	12,5	3-6,5
M16x1,5	OMB 02	10	21	7	18-17	16,5	4-8
M20x1,5	OMB 03	10	23	8	22-22	20,5	6-12
M25x1,5	OMB 04	10	24	8	27-24	25,5	10-14
M32x1,5	OMB 05	5	25	9	34-30	32,5	13-18
M40x1,5	OMB 06	5	31	9	43-40	40,5	18-25
M50x1,5	OMB 07	3	37	9	55-50	50,5	22-32
M63x1,5	OMB 08	2	38	14	68-64	63,5	34-44

NICKEL PLATED BRASS CABLE GLAND (PG)



PG	Code	Pcs in Box	H (mm)	GL (mm)	Spanner Size (mm)	Fitting Dia (mm)	Cable Dia (mm)
PG7	OPB 01	10	19	6	14	13	3-6,5
PG9	OPB 02	10	21	6	17	16	4-8
PG11	OPB 03	10	22	6	20	19	5-10
PG13,5	OPB 04	10	23	6,5	22	21	6-12
PG16	OPB 05	10	24	6,5	24	23	10-14
PG21	OPB 06	10	25	7	30	29	13-18
PG29	OPB 07	5	31	8	40	37,5	18-25
PG36	OPB 08	5	37	10	50	47,5	22-32
PG42	OPB 09	3	37	12	57	54,5	30-38
PG48	OPB 10	2	38	14	64	60	34-44

SLEEVED PLASTIC CABLE GLANDS (METRIC)

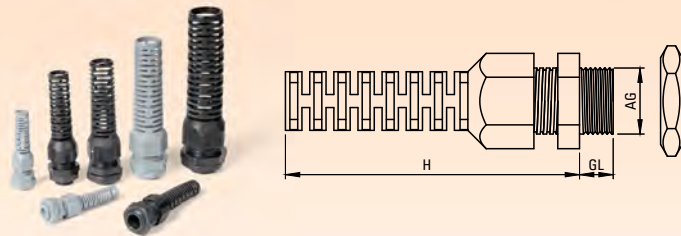

Metric	Code	Pcs in Box	H (mm)	GL (mm)	Spanner Size (mm)	Fitting Dia (mm)	Cable Dia (mm)
M12x1,5	OMR 17	10	57	8	15	12,5	3-6,5
M16x1,5	OMR 18	10	70	8	19	16,5	4-8
M16x1,5	OMR 19	10	81	10	22	16,5	5-10
M20x1,5	OMR 20	10	89	10	24	20,5	6-12
M20x1,5	OMR 21	5	107	10	27	20,5	10-14
M25x1,5	OMR 22	5	124	10	33	25,5	13-18

SLEEVED PLASTIC CABLE GLANDS (PG)

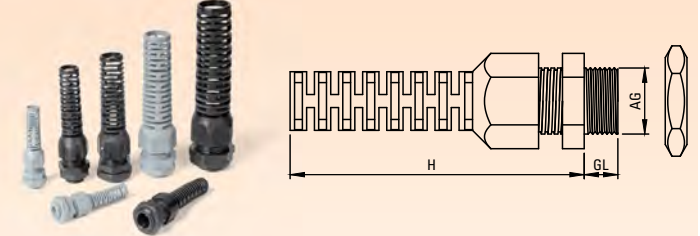

PG	Code	Pcs in Box	H (mm)	GL (mm)	Spanner Size (mm)	Fitting Dia (mm)	Cable Dia (mm)
PG7	OR 19	10	57	8	15	13	3-6,5
PG9	OR 20	10	70	8	19	16	4-8
PG11	OR 21	10	81	8	22	19	5-10
PG13,5	OR 22	5	89	9	24	21	6-12
PG16	OR 23	5	107	9	27	23	10-14
PG21	OR 24	5	124	11	33	29	13-18

BLIND STOPS



PG	Code	Pcs in Box	Metric	Code	Pcs in Box
PG7	OK 01	10	M12x1,5	MOK 01	10
PG9	OK 02	10	M16x1,5	MOK 02	10
PG11	OK 03	10	M20x1,5	MOK 03	10
PG13,5	OK 04	10	M25x1,5	MOK 04	10
PG16	OK 05	10	M32x1,5	MOK 05	10
PG21	OK 06	10	M40x1,5	MOK 06	10
PG29	OK 07	10			
PG36	OK 08	10			

MALE-FEMALE M3 BRASS STANDOFFS

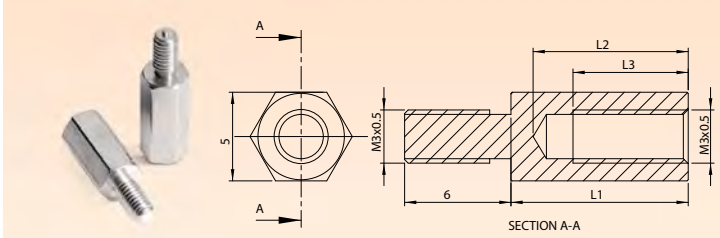

Code	L1	L2	L3	Pcs in Box	Code	L1	L2	L3	Pcs in Box
YP-505	5	4,5	3,5	50	YP-516	16	12	8	50
YP-506	6	5,5	5	50	YP-517	17	12	8	50
YP-507	7	6,5	6	50	YP-518	18	12	8	50
YP-508	8	7,5	7	50	YP-519	19	12	8	50
YP-509	9	8,5	7,5	50	YP-520	20	12	8	50
YP-510	10	9,5	8	50	YP-525	25	12	8	50
YP-511	11	10	8	50	YP-530	30	12	8	50
YP-512	12	11	8	50	YP-535	35	12	8	50
YP-513	13	12	8	50	YP-540	40	12	8	50
YP-514	14	12	8	50	YP-545	45	12	8	50
YP-515	15	12	8	50	YP-550	50	12	8	50

MALE-FEMALE M4 BRASS STANDOFFS

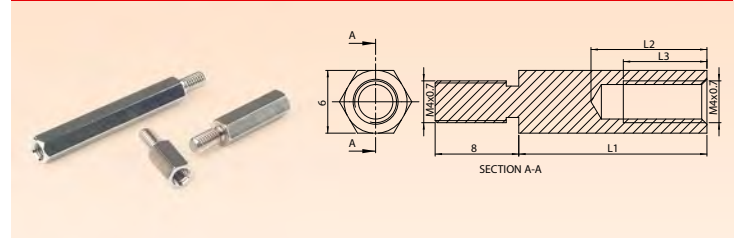

Code	L1	L2	L3	Pcs in Box	Code	L1	L2	L3	Pcs in Box
YP-4106	6	5,3	4	50	YP-4117	17	12	10	50
YP-4107	7	6,3	5	50	YP-4118	18	12	10	50
YP-4108	8	7,3	7	50	YP-4119	19	12	10	50
YP-4109	9	8,3	8	50	YP-4120	20	12	10	50
YP-4110	10	9,3	8	50	YP-4125	25	12	10	50
YP-4111	11	10,3	8	50	YP-4130	30	12	10	50
YP-4112	12	10,8	10	50	YP-4135	35	12	10	50
YP-4113	13	12	10	50	YP-4140	40	12	10	50
YP-4114	14	12	10	50	YP-4146	46	12	10	50
YP-4115	15	12	10	50	YP-4163	63	12	10	50
YP-4116	16	12	10	50					

FEMALE-FEMALE M3 BRASS STANDOFFS

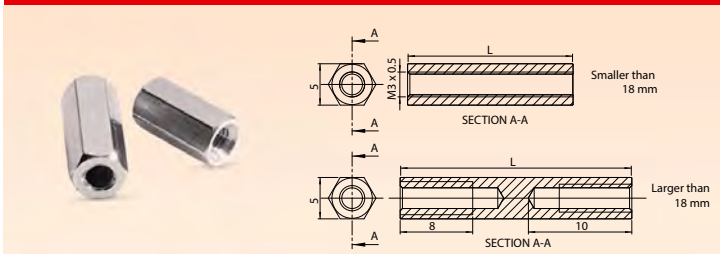

Code	L	Pcs in Box	Code	L	Pcs in Box
YP-405	5	50	YP-416	16	50
YP-406	6	50	YP-417	17	50
YP-407	7	50	YP-418	18	50
YP-408	8	50	YP-419	19	50
YP-409	9	50	YP-420	20	50
YP-410	10	50	YP-425	25	50
YP-411	11	50	YP-426	26	50
YP-412	12	50	YP-430	30	50
YP-413	13	50	YP-436	36	50
YP-414	14	50	YP-440	40	50
YP-415	15	50			

FEMALE-FEMALE M4 BRASS STANDOFFS

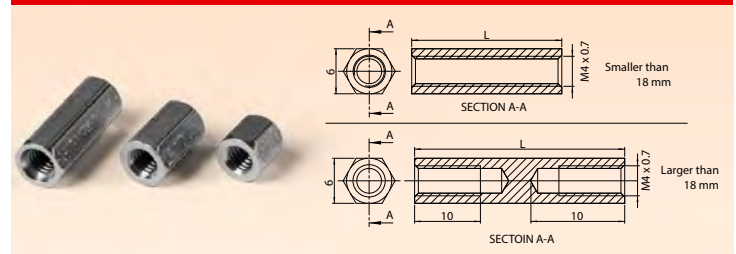

Code	L	Pcs in Box	Code	L	Pcs in Box
YP-4005	5	50	YP-4016	16	50
YP-4006	6	50	YP-4017	17	50
YP-4007	7	50	YP-4018	18	50
YP-4008	8	50	YP-4019	19	50
YP-4009	9	50	YP-4020	20	50
YP-4010	10	50	YP-4025	25	50
YP-4011	11	50	YP-4026	26	50
YP-4012	12	50	YP-4030	30	50
YP-4013	13	50	YP-4036	36	50
YP-4014	14	50	YP-4040	40	50
YP-4015	15	50			

MALE-MALE M4 BRASS STANDOFFS

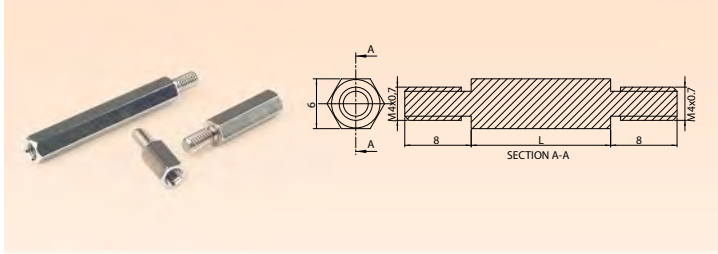

Code	L	Pcs in Box	Code	L	Pcs in Box
YP-4205	5	50	YP-4215	15	50
YP-4206	6	50	YP-4216	16	50
YP-4207	7	50	YP-4217	17	50
YP-4208	8	50	YP-4218	18	50
YP-4209	9	50	YP-4219	19	50
YP-4210	10	50	YP-4220	20	50
YP-4211	11	50	YP-4225	25	50
YP-4212	12	50	YP-4230	30	50
YP-4213	13	50	YP-4235	35	50
YP-4214	14	50	YP-4240	40	50

STANDOFF FOR PLASTIC PANEL MALE-FEMALE M3

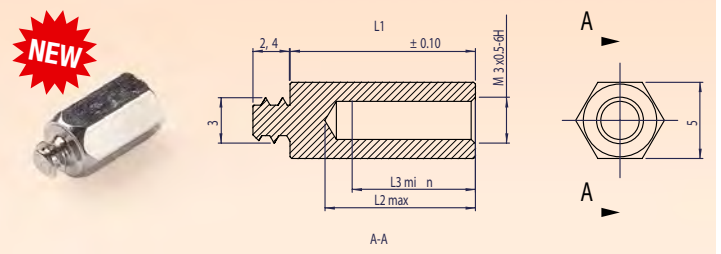

Code	L1	L2	L3	Pcs in Box
YP-3205	5	4,5	3,5	50
YP-3206	6	5,5	5	50
YP-3207	7	6,5	6	50
YP-3208	8	7,5	7	50
YP-3209	9	8,5	7,5	50
YP-3210	10	9,5	8	50
YP-3211	11	10	8	50
YP-3212	12	11	8	50

MALE-FEMALE STANDOFF FOR PLASTIC BOSSES

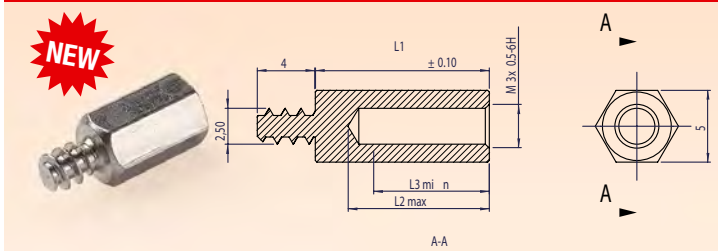

Code	L1	L2	L3	Pcs in Box
YP-3305	5	4,5	3,5	50
YP-3306	6	5,5	5	50
YP-3307	7	6,5	6	50
YP-3308	8	7,5	7	50
YP-3309	9	8,5	7,5	50
YP-3310	10	9,5	8	50
YP-3311	11	10	8	50
YP-3312	12	11	8	50

MALE-FEMALE STANDOFF FOR PLASTIC BOSSES

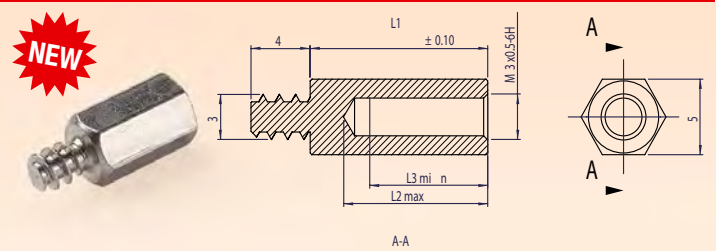

Code	L1	L2	L3	Pcs in Box	Code	L1	L2	L3	Pcs in Box
YP-3405	5	4,5	3,5	50	YP-3416	5	11	8	50
YP-3406	6	5,5	5	50	YP-3417	6	11	8	50
YP-3407	7	6,5	6	50	YP-3418	7	11	8	50
YP-3408	8	7,5	7	50	YP-3419	8	11	8	50
YP-3409	9	8,5	7,5	50	YP-3420	9	11	8	50
YP-3410	10	9,5	8	50	YP-3421	10	11	8	50
YP-3411	11	10	8	50	YP-3422	11	11	8	50
YP-3412	12	11	8	50	YP-3423	12	11	8	50
YP-3413	5	11	8	50	YP-3424	5	11	8	50
YP-3414	6	11	8	50	YP-3425	6	11	8	50
YP-3415	7	11	8	50					

MALE-FEMALE STANDOFF FOR PLASTIC BOSSES

NEW

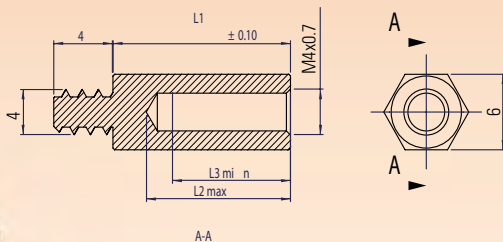

Code	L1	L2	L3	Pcs in Box	Code	L1	L2	L3	Pcs in Box
YP-4405	5	4,5	3,5	50	YP-4416	5	11	8	50
YP-4406	6	5,5	5	50	YP-4417	6	11	8	50
YP-4407	7	6,5	6	50	YP-4418	7	11	8	50
YP-4408	8	7,5	7	50	YP-4419	8	11	8	50
YP-4409	9	8,5	7,5	50	YP-4420	9	11	8	50
YP-4410	10	9,5	8	50	YP-4421	10	11	8	50
YP-4411	11	10	8	50	YP-4422	11	11	8	50
YP-4412	12	11	8	50	YP-4423	12	11	8	50
YP-4413	5	11	8	50	YP-4424	5	11	8	50
YP-4414	6	11	8	50	YP-4425	6	11	8	50
YP-4415	7	11	8	50					

PCB SOLDERABLE STANDOFFS

NEW

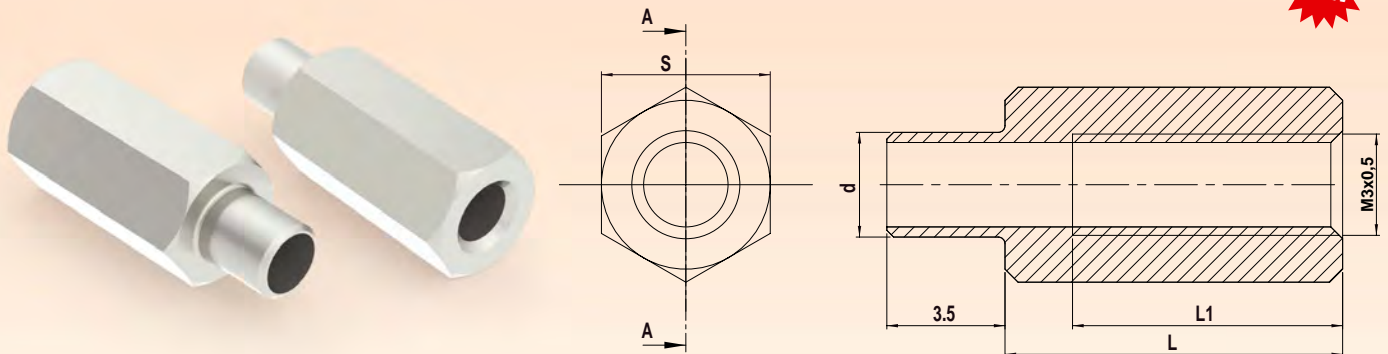

- Brass, Tin coated
- Solderable to PCB can be used in wave soldering
- Can be used for mechanical or electrical connection

Code	L	L1	d	S
YP-035-5	5	8	3,1	5
YP-035-6	6	8	3,1	5
YP-035-7	7	8	3,1	5
YP-035-8	8	8	3,1	5
YP-035-9	9	8	3,1	5
YP-035-10	10	8	3,1	5
YP-035-11	11	8	3,1	5
YP-035-12	12	8	3,1	5
YP-035-13	13	8	3,1	5
YP-035-14	14	8	3,1	5
YP-035-15	15	8	3,1	5

PLASTIC SELF-LOCKING SPACERS

MATERIAL PA 66
COLOR NATURAL



Hole Dia: $4 \pm 0.08\text{mm}$
Panel Thickness: 2 mm max.



Hole Dia: 4.75 ± 0.08
Sheet Thickness: 0,8 - 2,0 mm

- Offers easy mounting of PCB cards on enclosures
- Speeds up mounting
- Isolates PCB from enclosure
- PCB can easily detach by special lock mechanism

Code	B mm
YP-805	4,75
YP-810	9,53
YP-816	15,9
YP-822	22,2

PLASTIC STANDOFFS

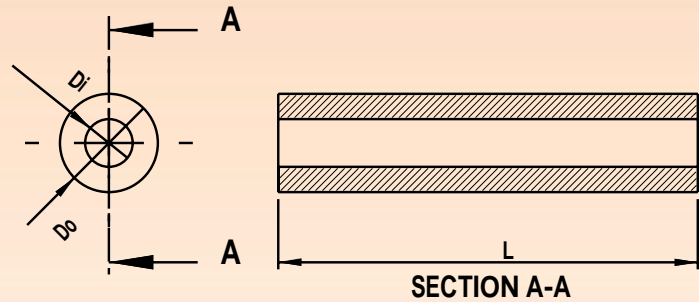

Code	Material	Di	Do	L
YP-605	PA6	2,5	5	5
YP-606	PA6	2,5	5	6
YP-607	PA6	2,5	5	7
YP-608	PA6	2,5	5	8
YP-609	PA6	2,5	5	9
YP-610	PA6	2,5	5	10
YP-611	PA6	2,5	5	11
YP-612	PA6	2,5	5	12
YP-613	PA6	2,5	5	13
YP-614	PA6	2,5	5	14
YP-615	PA6	2,5	5	15
YP-616	PA6	2,5	5	16
YP-617	PA6	2,5	5	17
YP-618	PA6	2,5	5	18
YP-619	PA6	2,5	5	19
YP-620	PA6	2,5	5	20
YP-621	PA6	2,5	5	21
YP-622	PA6	2,5	5	22
YP-623	PA6	2,5	5	23
YP-624	PA6	2,5	5	24
YP-625	PA6	2,5	5	25
YP-630	PA6	2,5	5	30
YP-635	PA6	2,5	5	35
YP-640	PA6	2,5	5	40
YP-645	PA6	2,5	5	45
YP-650	PA6	2,5	5	50

Code	Material	Di	Do	L
YP-701	PA6	3	7	1
YP-702	PA6	3	7	2
YP-703	PA6	3	7	3
YP-704	PA6	3	7	4
YP-705	PA6	3	7	5
YP-706	PA6	3	7	6
YP-708	PA6	3	7	8
YP-710	PA6	3	7	10
YP-712	PA6	3	7	12
YP-715	PA6	3	7	15
YP-720	PA6	3	7	20
YP-725	PA6	3	7	25
YP-730	PA6	3	7	30
YP-735	PA6	3	7	35
YP-740	PA6	3	7	40
YP-745	PA6	3	7	45
YP-750	PA6	3	7	50

Code	Material	Di	Do	L
YP-905	PA6	4,2	8	5
YP-906	PA6	4,2	8	6
YP-907	PA6	4,2	8	7
YP-908	PA6	4,2	8	8
YP-909	PA6	4,2	8	9
YP-910	PA6	4,2	8	10
YP-911	PA6	4,2	8	11
YP-912	PA6	4,2	8	12
YP-913	PA6	4,2	8	13
YP-914	PA6	4,2	8	14
YP-915	PA6	4,2	8	15
YP-916	PA6	4,2	8	16
YP-917	PA6	4,2	8	17
YP-918	PA6	4,2	8	18
YP-919	PA6	4,2	8	19
YP-920	PA6	4,2	8	20
YP-921	PA6	4,2	8	21
YP-922	PA6	4,2	8	22
YP-923	PA6	4,2	8	23
YP-924	PA6	4,2	8	24
YP-925	PA6	4,2	8	25
YP-930	PA6	4,2	8	30
YP-935	PA6	4,2	8	35
YP-940	PA6	4,2	8	40
YP-945	PA6	4,2	8	45
YP-950	PA6	4,2	8	50

PLASTIC STANDOFFS

NEW

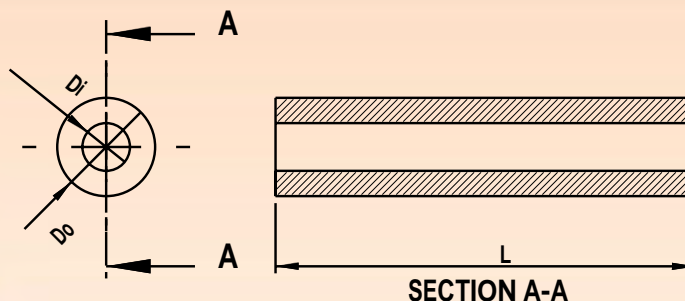

Code	Material	Di	Do	L	Code	Material	Di	Do	L	Code	Material	Di	Do	L
YP-5705	PA6	5,3	8	5	YP-6705	PA6	6,3	10	5	YP-8705	PA6	8,3	12	5
YP-5706	PA6	5,3	8	6	YP-6706	PA6	6,3	10	6	YP-8706	PA6	8,3	12	6
YP-5707	PA6	5,3	8	7	YP-6707	PA6	6,3	10	7	YP-8707	PA6	8,3	12	7
YP-5708	PA6	5,3	8	8	YP-6708	PA6	6,3	10	8	YP-8708	PA6	8,3	12	8
YP-5709	PA6	5,3	8	9	YP-6709	PA6	6,3	10	9	YP-8709	PA6	8,3	12	9
YP-5710	PA6	5,3	8	10	YP-6710	PA6	6,3	10	10	YP-8710	PA6	8,3	12	10
YP-5711	PA6	5,3	8	11	YP-6711	PA6	6,3	10	11	YP-8711	PA6	8,3	12	11
YP-5712	PA6	5,3	8	12	YP-6712	PA6	6,3	10	12	YP-8712	PA6	8,3	12	12
YP-5713	PA6	5,3	8	13	YP-6713	PA6	6,3	10	13	YP-8713	PA6	8,3	12	13
YP-5714	PA6	5,3	8	14	YP-6714	PA6	6,3	10	14	YP-8714	PA6	8,3	12	14
YP-5715	PA6	5,3	8	15	YP-6715	PA6	6,3	10	15	YP-8715	PA6	8,3	12	15
YP-5716	PA6	5,3	8	16	YP-6716	PA6	6,3	10	16	YP-8716	PA6	8,3	12	16
YP-5717	PA6	5,3	8	17	YP-6717	PA6	6,3	10	17	YP-8717	PA6	8,3	12	17
YP-5718	PA6	5,3	8	18	YP-6718	PA6	6,3	10	18	YP-8718	PA6	8,3	12	18
YP-5719	PA6	5,3	8	19	YP-6719	PA6	6,3	10	19	YP-8719	PA6	8,3	12	19
YP-5720	PA6	5,3	8	20	YP-6720	PA6	6,3	10	20	YP-8720	PA6	8,3	12	20
YP-5721	PA6	5,3	8	21	YP-6721	PA6	6,3	10	21	YP-8721	PA6	8,3	12	21
YP-5722	PA6	5,3	8	22	YP-6722	PA6	6,3	10	22	YP-8722	PA6	8,3	12	22
YP-5723	PA6	5,3	8	23	YP-6723	PA6	6,3	10	23	YP-8723	PA6	8,3	12	23
YP-5724	PA6	5,3	8	24	YP-6724	PA6	6,3	10	24	YP-8724	PA6	8,3	12	24
YP-5725	PA6	5,3	8	25	YP-6725	PA6	6,3	10	25	YP-8725	PA6	8,3	12	25
YP-5730	PA6	5,3	8	30	YP-6730	PA6	6,3	10	30	YP-8730	PA6	8,3	12	30
YP-5735	PA6	5,3	8	35	YP-6735	PA6	6,3	10	35	YP-8735	PA6	8,3	12	35
YP-5740	PA6	5,3	8	40	YP-6740	PA6	6,3	10	40	YP-8740	PA6	8,3	12	40
YP-5745	PA6	5,3	8	45	YP-6745	PA6	6,3	10	45	YP-8745	PA6	8,3	12	45
YP-5750	PA6	5,3	8	50	YP-6750	PA6	6,3	10	50	YP-8750	PA6	8,3	12	50

LED PIPES

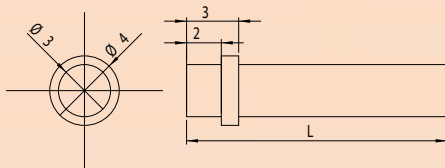

Code	L	Pcs in Box
LG-07	7	250
LG-08	8	250
LG-09	9	250
LG-10	10	250
LG-11	11	250
LG-12	12	250
LG-13	13	250
LG-14	14	250
LG-15	15	250
LG-16	16	250
LG-17	17	250
LG-18	18	250
LG-19	19	250
LG-20	20	250
LG-21	21	250
LG-22	22	250
LG-23	23	250
LG-24	24	250
LG-25	25	250
LG-26	26	250
LG-30	30	250
LG-35	35	250
LG-40	40	250
LG-45	45	250
LG-50	50	250

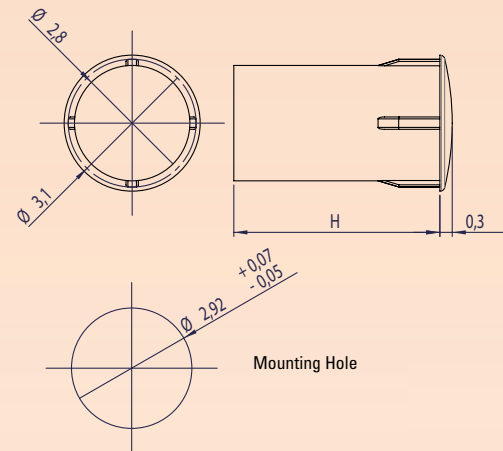
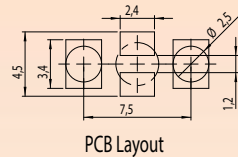
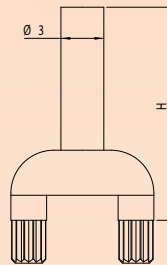

Code	H	Pcs in Box
LG-110	10	250
LG-111	11	250
LG-112	12	250
LG-114	14	250
LG-116	16	250
LG-118	18	250
LG-120	20	250
LG-123	23	250
LG-125	25	250
LG-130	30	250

Code	H	Pcs in Box
LG-2050	5	250
LG-2060	6	250
LG-2070	7	250
LG-2080	8	250
LG-2090	9	250
LG-2100	10	250
LG-2110	11	250
LG-2120	12	250
LG-2130	13	250
LG-2140	14	250
LG-2150	15	250
LG-2175	17,5	250
LG-2200	20	250
LG-2225	22,5	250
LG-2250	25	250
LG-2275	27,5	250
LG-2300	30	250
LG-2325	32,5	250
LG-2350	35	250

LED PIPES

NEW

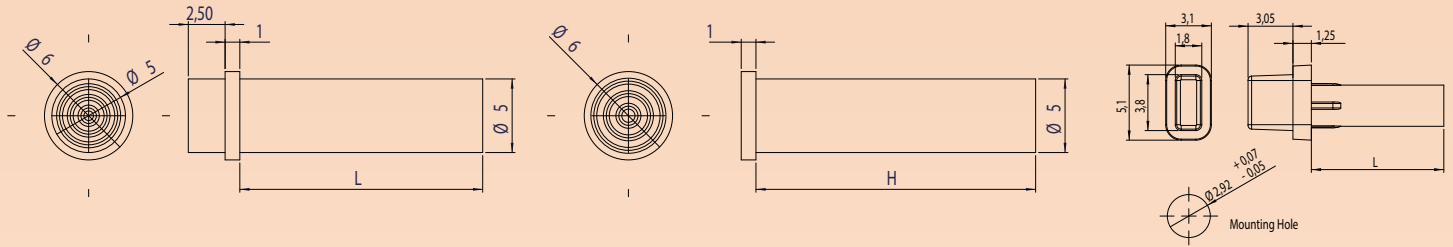

Code	L	Pcs in Box
LG-5005	5	250
LG-5006	6	250
LG-5007	7	250
LG-5008	8	250
LG-5009	9	250
LG-5010	10	250
LG-5011	11	250
LG-5012	12	250
LG-5013	13	250
LG-5014	14	250
LG-5015	15	250
LG-5016	16	250
LG-5017	17	250
LG-5018	18	250

Code	L	Pcs in Box
LG-5019	19	250
LG-5020	20	250
LG-5021	21	250
LG-5022	22	250
LG-5023	23	250
LG-5024	24	250
LG-5025	25	250
LG-5026	26	250
LG-5030	30	250
LG-5035	35	250
LG-5040	40	250
LG-5045	45	250
LG-5050	50	250

Code	L	Pcs in Box
LG-5105	5	250
LG-5106	6	250
LG-5107	7	250
LG-5108	8	250
LG-5109	9	250
LG-5110	10	250
LG-5111	11	250
LG-5112	12	250
LG-5113	13	250
LG-5114	14	250
LG-5115	15	250
LG-5116	16	250
LG-5117	17	250
LG-5118	18	250

Code	L	Pcs in Box
LG-5119	19	250
LG-5120	20	250
LG-5121	21	250
LG-5122	22	250
LG-5123	23	250
LG-5124	24	250
LG-5125	25	250
LG-5126	26	250
LG-5130	30	250
LG-5135	35	250
LG-5140	40	250
LG-5145	45	250
LG-5150	50	250

Code	L	Pcs in Box
LG-2505	5	250
LG-2506	6	250
LG-2507	7	250
LG-2508	8	250
LG-2509	9	250
LG-2510	10	250
LG-2511	11	250
LG-2512	12	250
LG-2513	13	250
LG-2514	14	250
LG-2515	15	250
LG-2516	16	250
LG-2517	17,5	250
LG-2520	20	250
LG-2522	22,5	250
LG-2525	25	250
LG-2527	27,5	250
LG-2530	30	250
LG-2532	32,5	250
LG-2535	35	250

LG-310

3 mm LED GASKET

NEW



LG-310

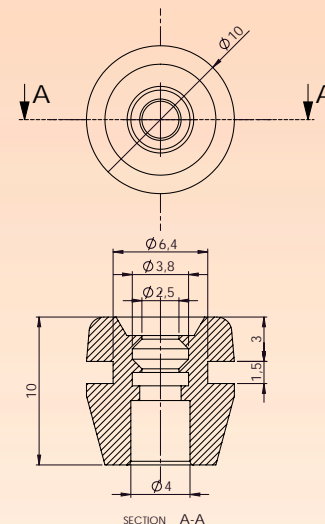

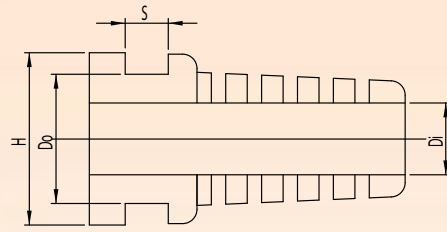

Code	Di	Do	H	S
A-905	5	9	11,5	2,8
A-909	5	9	12	2,5
A-913	6	14	15	2,8
A-914	8	11	15,5	2,8
A-915	10	13	17,3	2,3
A-907	4	9	11,5	2,8

SLEEVED CABLE GROMMETS

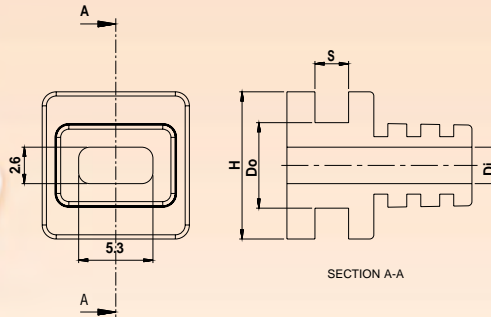

Code	DI	DO	H	S
A-903	2x0,75	6,5	10,5	2,3

2 x 0,75 mm CABLE GROMMET

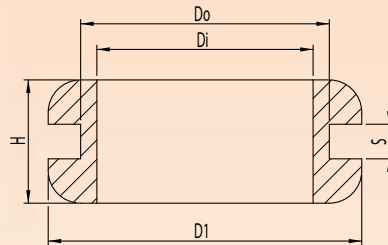

Code	Di	Do	D1	H	S
A-904	4	5,5	9	5	1,5
A-906	6	8	11,3	4,3	1,5
A-908	8	10	13	5,2	1,5
A-910	10	11,5	14	6	1,6
A-912	12	15	19,5	5,5	1,8

CABLE GROMMETS

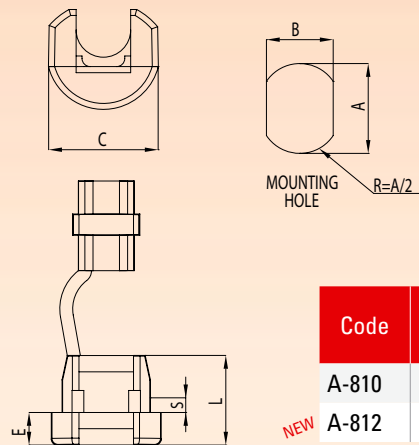

Code	A (mm)	B (mm)	C (mm)	L (mm)	E (mm)	S (mm)
A-810	12,7	10,9	13,5	11	4	1,8
NEW A-812	16,2	13,5	16,5	15	6	1,9

SEPARABLE GROMMET

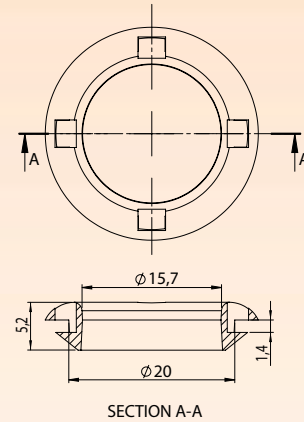

CABLE BUSHING A-920

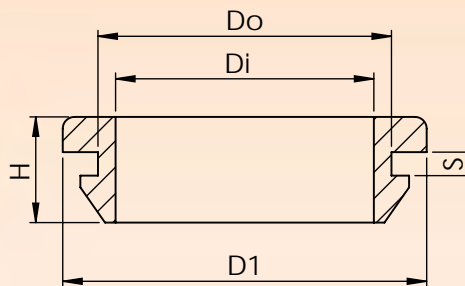

Code	Di	Do	D1	H	S
A-820	16	20	26	9	2
A-825	22	25	31	9	2
A-850	46	50	58	9	2

CABLE GROMMETS

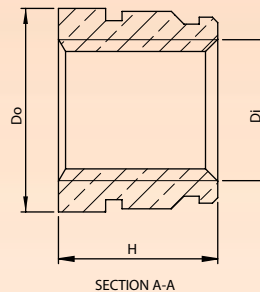

Code	Di	Do	H (mm)
IN-203	M2	3.60	3
IN-204	M2.5	4.60	4
A-651	M3	4.60	5.75
A-649	M4	6.30	4
A-650	M4	6.30	8
IN-506	M5	7.07	5.8
IN-607	M6	8.67	6.8

BRASS INSERTS

- Can be mounted using ultrasonic, press fit or in-mould during injection

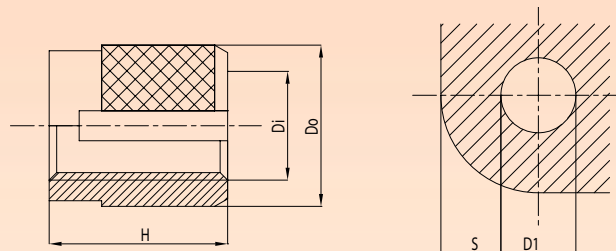

- Press fit into suitable hole.
- During first screw mounting it expands and locks in.

Code	Di (mm)	Do (mm)	H (mm)	D1 (mm)	S (mm)
IN-347	M3	4,3	4,76	Ø4	3,2
IN-479	M4	5,95	7,9	Ø5,6	4

EXPANSION INSERTS

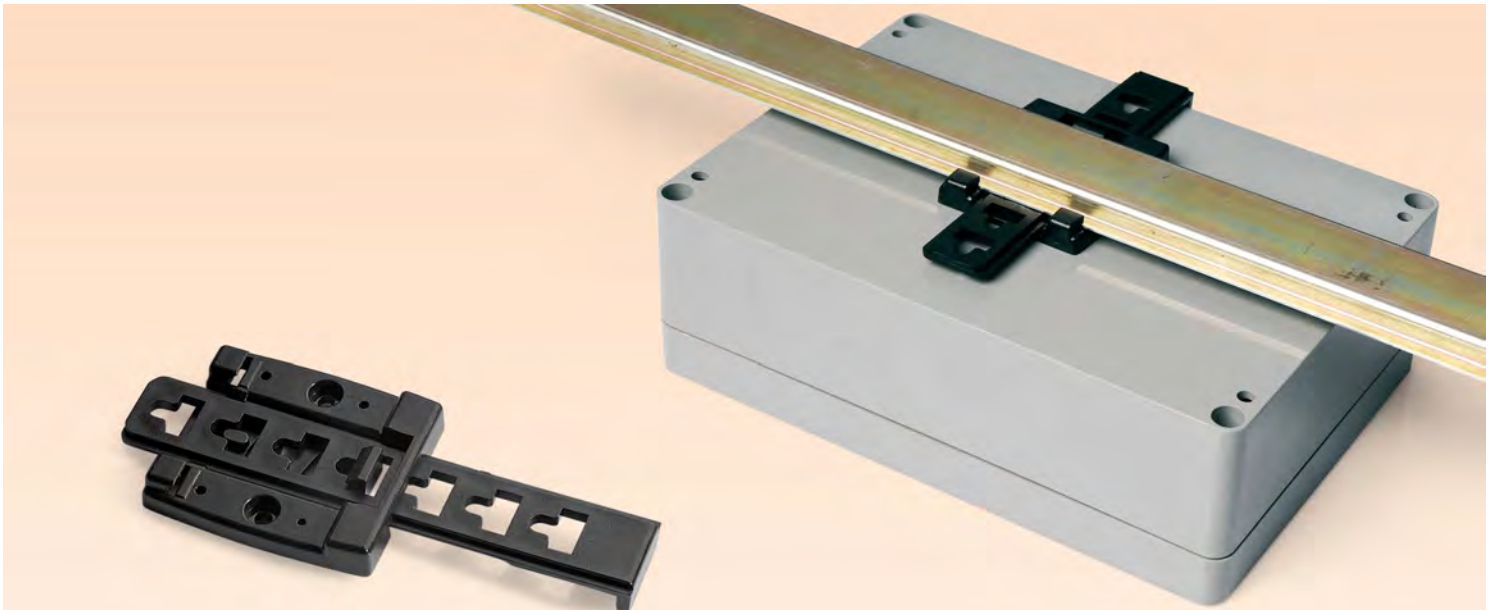

A-116 DIN RAIL MOUNTING KIT

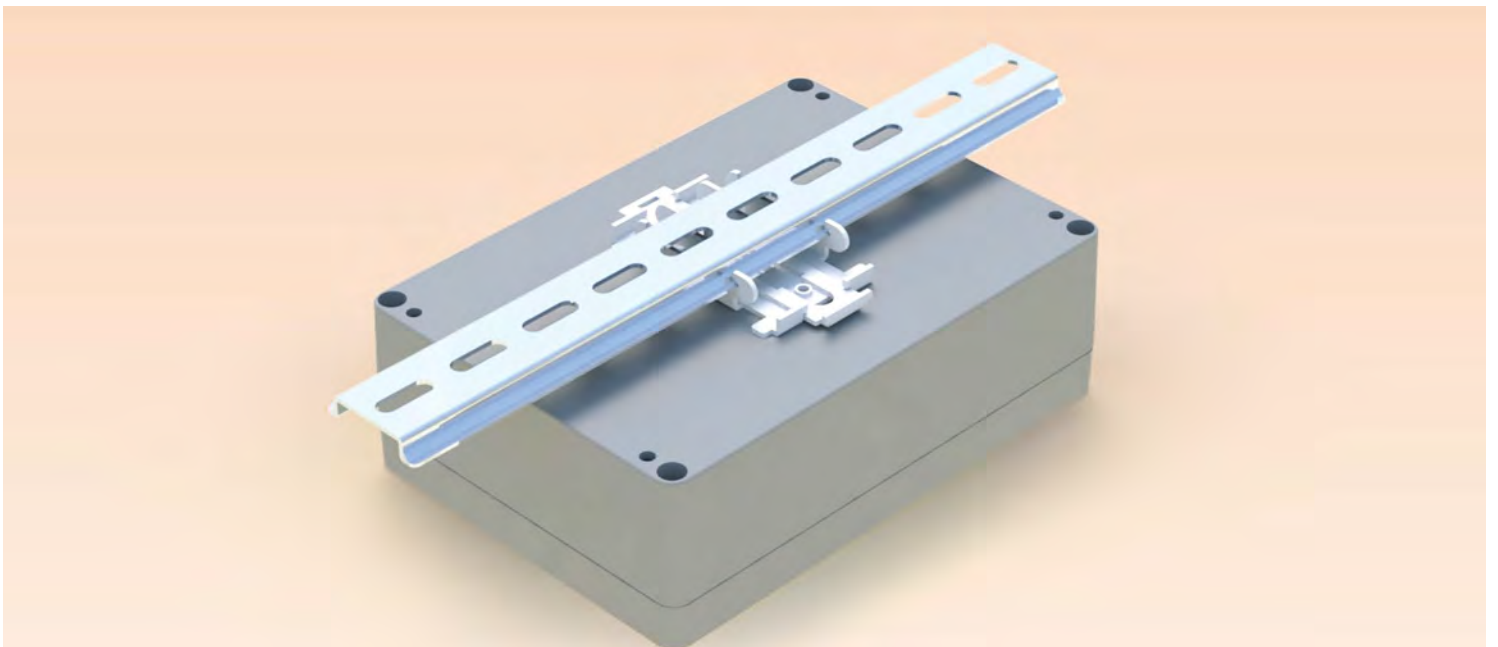

A-117 METAL DIN RAIL MOUNTING KIT



Code	Size	Description
AL-035-10	35 x 7,3 x 100 mm	Aluminium DIN Rail 10 cm
AL-035-20	35 x 7,3 x 200 mm	Aluminium DIN Rail 20 cm
AL-035-30	35 x 7,3 x 300 mm	Aluminium DIN Rail 30 cm
AL-035-40	35 x 7,3 x 400 mm	Aluminium DIN Rail 40 cm
AL-035-50	35 x 7,3 x 500 mm	Aluminium DIN Rail 50 cm
AL-035-100	35 x 7,3 x 1000 mm	Aluminium DIN Rail 100 cm
AL-035-200	35 x 7,3 x 2000 mm	Aluminium DIN Rail 200 cm

ALUMINIUM DIN RAIL

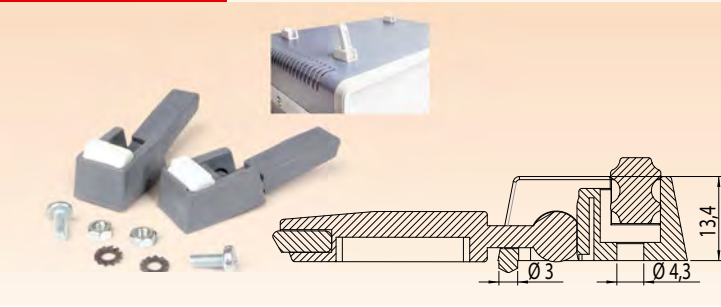
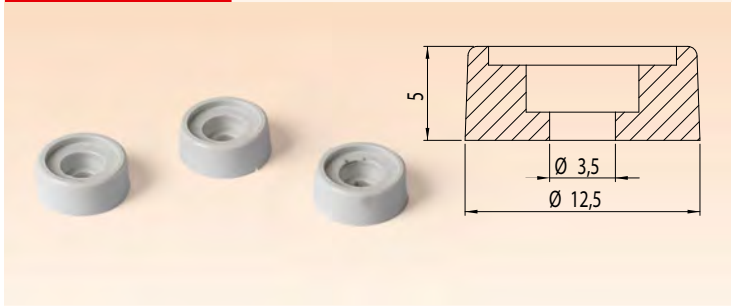
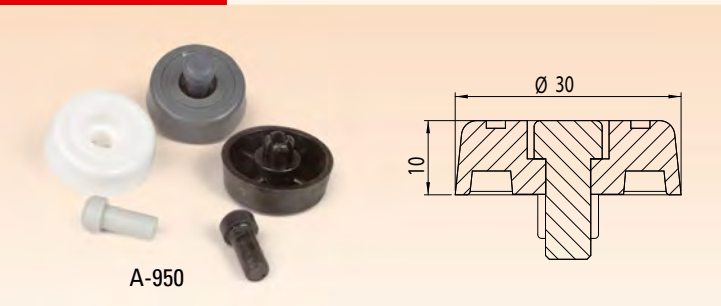
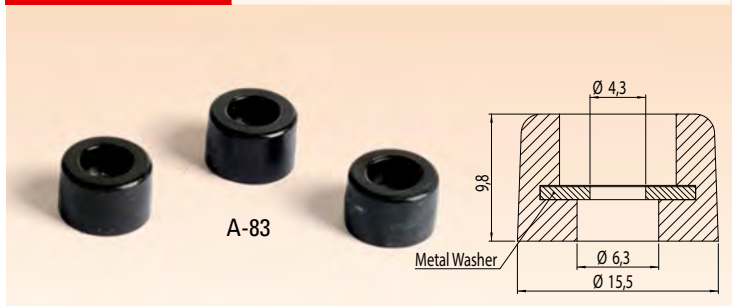
A-951**TILTING FOOT KIT****A-082****PLASTIC FOOT****A-950****BUMPER FOOT****A-083****RUBBER FOOT (W/ METALWASHER)****A-58 A-59****WALL MOUNTING KITS**

A-58	CLICK WALL MOUNT
A-59	SCREWED WALL MOUNT

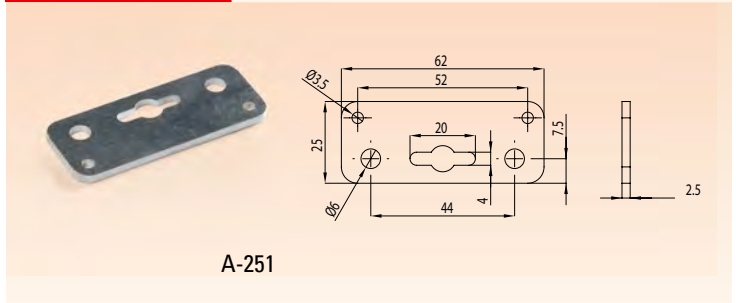
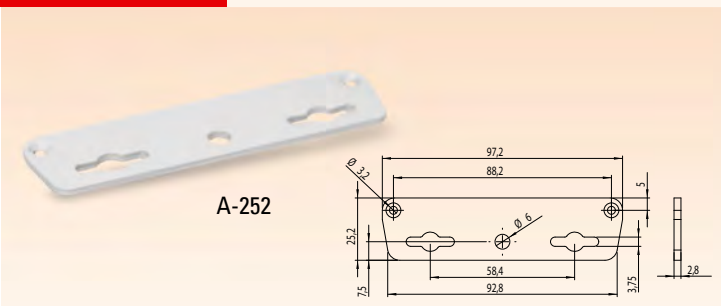
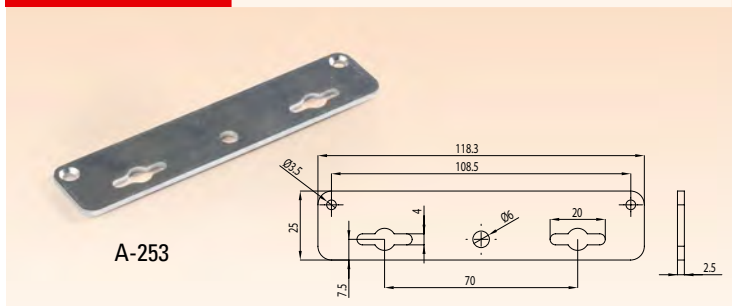
**A-251****WALL MOUNT****A-252****WALL MOUNT****A-253****WALL MOUNT****A-340****PLASTIC DIN RAIL****A-410****RACK DOWEL**

A-782**CEILING MOUNT**

COLOR LIGHT GRAY



A-782

A-366**WALL MOUNT KIT**COLOR LIGHT GRAY / BLACK
MATERIAL ABS

A-366

KL-40**STAINLESS HINGE SET**

KL-40

KL-50**STAINLESS LATCH**
(Suitable for EC-1515 ,EC-1722, EC-2818)

KL-50

KL-55**STAINLESS LATCH SET (SMALL)**

KL-55

KL-60**STAINLESS HOOK SET**

KL-60

KL-70**STAINLESS LATCH**
(Suitable for EC-2828, EC-3040 , EC-4050)

KL-70

KL-75**STAINLESS LATCH SET (BIG)**

KL-75

EC-20**ALUMINIUM WALL MOUNTING LUGS**

EC-20

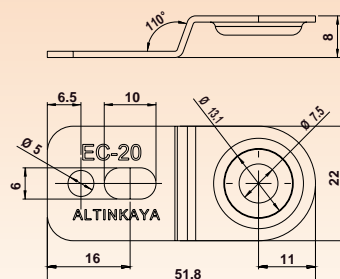
**EC-22****PLASTIC WALL MOUNTING LUGS**

EC-22

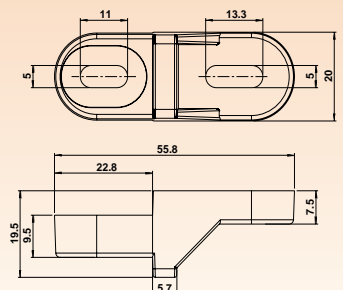

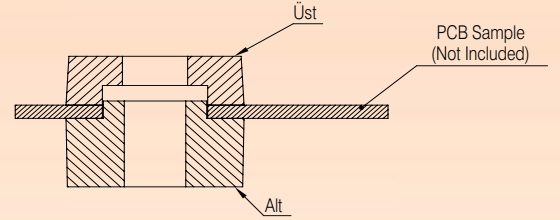
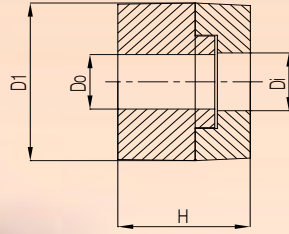

• CAN BE USED TO ISOLATE PCB.

Code	Di (mm)	Do (mm)	D1 (mm)	H (mm)
A-124	Ø5	Ø5	Ø17,5	14
A-126	Ø7	Ø6,6	Ø19,4	14,7

ISOLATION WASHERS



TILTING FOOT A-57

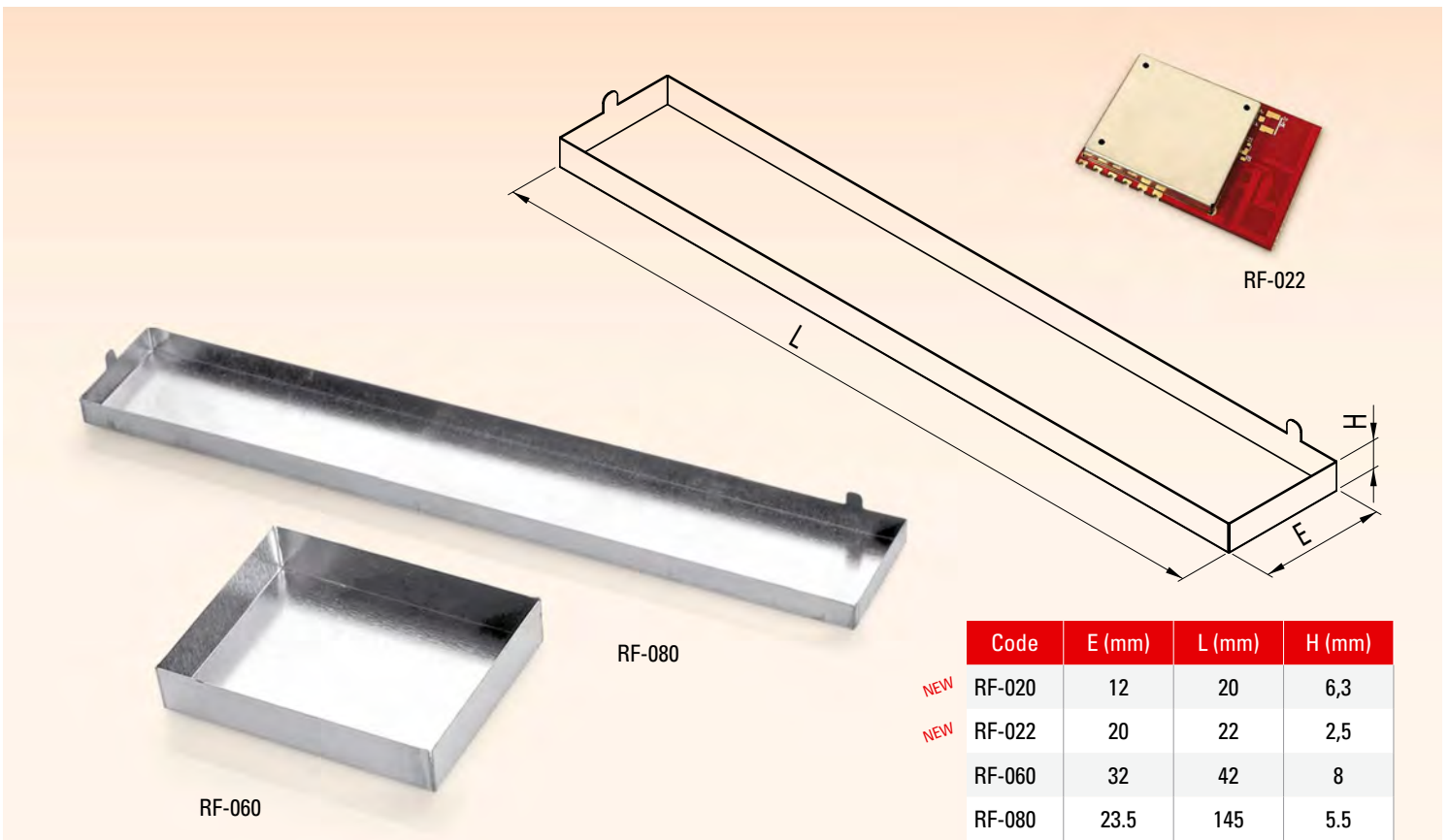

	Code	E (mm)	L (mm)	H (mm)
NEW	RF-020	12	20	6,3
NEW	RF-022	20	22	2,5
	RF-060	32	42	8
	RF-080	23.5	145	5.5

RF SHIELDS

A-330

MATERIAL ABS / ALUMINIUM
 COLOR BLACK

HANDLES

NEW

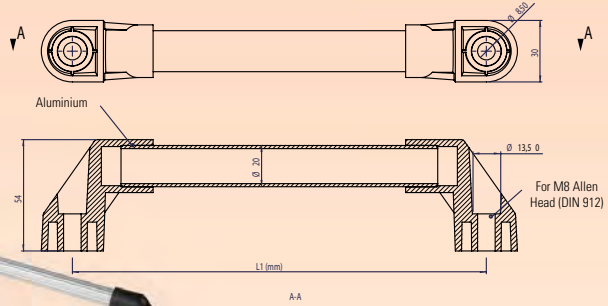

Code	L1
A-330-20	200
A-330-30	300
A-330-40	400
A-330-50	500
A-330-70	700

A-332

HANDLES

NEW

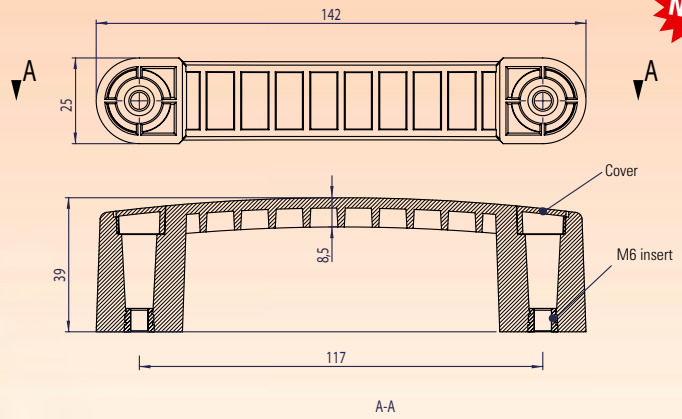
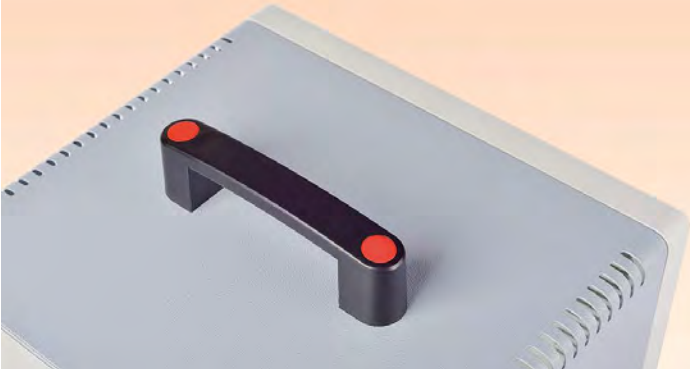

A-370

HANDLES

NEW



METAL HANDLE

- A-97 185 mm Axial distance
- A-98 132 mm Axial distance



PLASTIC VENTILATION

- A-310 Plastic Ventilation



BATTERY CAP

- A-49 Battery Cap 25x31
- A-50 Battery Cap 25x56



TRIM POT KNOBS

- A-80 Thick Trim Pot
- A-81 Thin Trim Pot

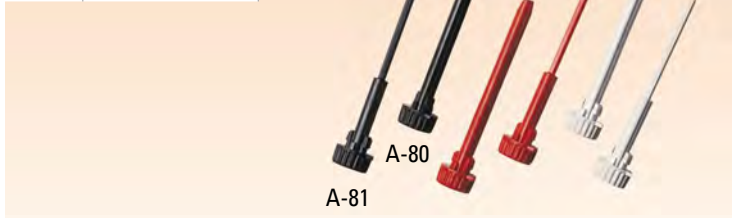

PLASTIC KNOBS

- A-110 Knob 5,8 x 14 x 15
- A-111 Knob 5,8 x 14 x 5,8



BELT CLIPS

- A-191 Stainless Belt Clips
- A-190 Abs Belt Clips



LOCK

- A-45 Nickel Bag Locker



SEALED HINGE

- A-250 Sealed Hinge



PLASTIC BUTTONs

- A-700 Big Triangle Button
- A-701 Big Rectangle Button
- A-702 Small Triangle Button
- A-703 Small Rectangle Button



CARD RAILS

- A-921 Plastic Card Rail
- A-922 Plastic Card Rail (2 Rails)
- A-923 4,5 "Plastic Card Rail

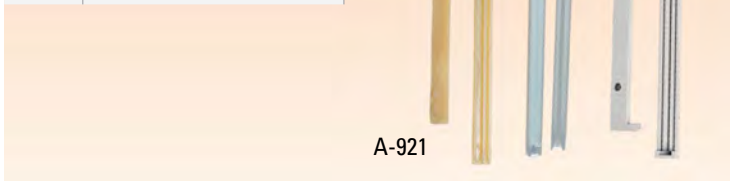

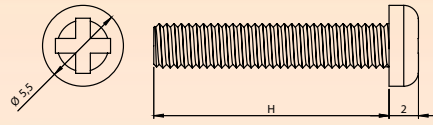

- Polyacetal (POM) Material
- PH Head
- M3 6-16mm Length
- Useful for mounting PCB

Code	
PN-300	M3 NUT

Code	H (mm)	
PS-306	6	6 mm YSB M3 Screw
PS-308	8	8 mm YSB M3 Screw
PS-310	10	10 mm YSB M3 Screw
PS-312	12	12 mm YSB M3 Screw
PS-316	16	16 mm YSB M3 Screw

PLASTIC SCREWS AND NUTS

FS-80

80 mm FAN HEATSINK

MATERIAL 2 mm Aluminium

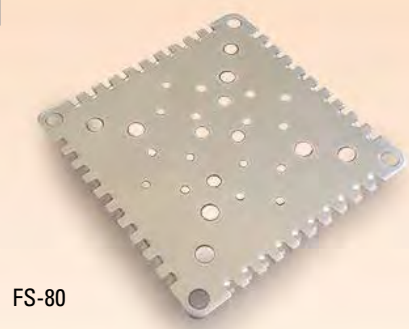

FS-80

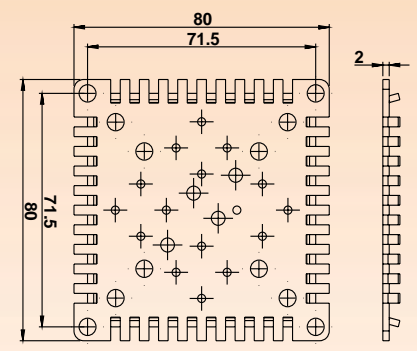

CLINCHING BLIND STANDOFFS

For proper assembly sheet thickness needs to be bigger than sheet thickness on the table. For better assembly do not deburr hole before assembly and press fit from burr side. Distance from hole center to the sheet edge should be higher than table. Default material is Steel with Cr3+ finish.

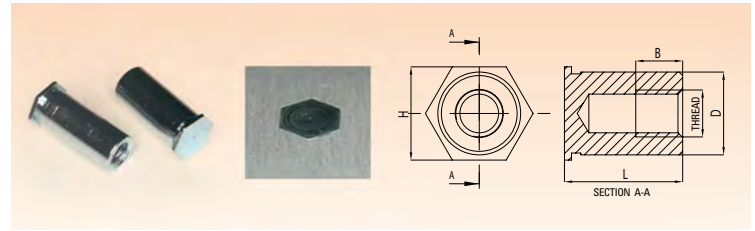

Code	Thread (mm)	L +0.05/-0.13 (mm)	H (Norm)	D -0.13 (mm)	Min. Sheet Thickness (mm)	Rec Hole Size in Sheet +0.08 (mm)	Min. Dist. Hole C/L to Edge (mm)
BSO-M3-6	M3x6	6	4,8	4,2	1,02	4,22	6
BSO-M3-8	M3x8	8	4,8	4,2	1,02	4,22	6
BSO-M3-10	M3x10	10	4,8	4,2	1,02	4,22	6
BSO-M3-12	M3x12	12	4,8	4,2	1,02	4,22	6
BSO-M3-14	M3x14	14	4,8	4,2	1,02	4,22	6
BSO-M3-16	M3x16	16	4,8	4,2	1,02	4,22	6
BSO-M3-18	M3x18	18	4,8	4,2	1,02	4,22	6
BSO-M3-20	M3x20	20	4,8	4,2	1,02	4,22	6
BSO-M3-22	M3x22	22	4,8	4,2	1,02	4,22	6
BSO-M3-24	M3x24	24	4,8	4,2	1,02	4,22	6
BSO-M3-25	M3x25	25	4,8	4,2	1,02	4,22	6
BSO-M3-26	M3x26	26	4,8	4,2	1,02	4,22	6
BSO-M4-6	M4x6	6	7,9	7,12	1,27	7,14	8
BSO-M4-8	M4x8	8	7,9	7,12	1,27	7,14	8
BSO-M4-10	M4x10	10	7,9	7,12	1,27	7,14	8
BSO-M4-12	M4x12	12	7,9	7,12	1,27	7,14	8
BSO-M4-14	M4x14	14	7,9	7,12	1,27	7,14	8
BSO-M4-16	M4x16	16	7,9	7,12	1,27	7,14	8
BSO-M4-18	M4x18	18	7,9	7,12	1,27	7,14	8
BSO-M4-20	M4x20	20	7,9	7,12	1,27	7,14	8
BSO-M4-22	M4x22	22	7,9	7,12	1,27	7,14	8
BSO-M4-24	M4x24	24	7,9	7,12	1,27	7,14	8
BSO-M4-25	M4x25	25	7,9	7,12	1,27	7,14	8
BSO-M4-26	M4x26	26	7,9	7,12	1,27	7,14	8
BSO-M5-6	M5x6	6	7,9	7,12	1,27	7,14	8
BSO-M5-8	M5x8	8	7,9	7,12	1,27	7,14	8
BSO-M5-10	M5x10	10	7,9	7,12	1,27	7,14	8
BSO-M5-12	M5x12	12	7,9	7,12	1,27	7,14	8
BSO-M5-14	M5x14	14	7,9	7,12	1,27	7,14	8
BSO-M5-16	M5x16	16	7,9	7,12	1,27	7,14	8
BSO-M5-18	M5x18	18	7,9	7,12	1,27	7,14	8
BSO-M5-20	M5x20	20	7,9	7,12	1,27	7,14	8
BSO-M5-22	M5x22	22	7,9	7,12	1,27	7,14	8
BSO-M5-24	M5x24	24	7,9	7,12	1,27	7,14	8
BSO-M5-25	M5x25	25	7,9	7,12	1,27	7,14	8
BSO-M5-26	M5x26	26	7,9	7,12	1,27	7,14	8

CLINCHING NUTS

For proper assembly sheet thickness needs to be bigger than sheet thickness on the table. For better assembly do not deburr hole before assembly and press fit from burr side. Distance from hole center to the sheet edge should be higher than table. Default material is Steel with Cr3+ finish.

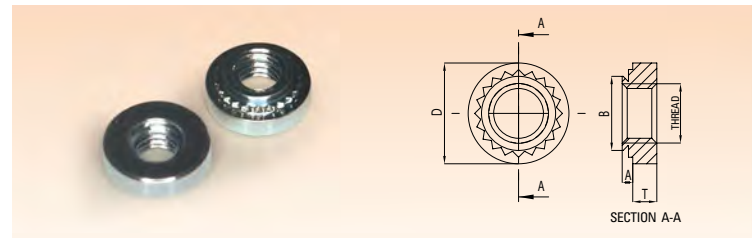

Code	Thread (mm)	A (Shank) Max. (mm)	Min. Sheet Thickness (mm)	Rec Hole Size in Sheet +0.08 (mm)	D ±0.25 (mm)	B Max. (mm)	T ±0.25 (mm)	Min. Dist. Hole C/L to Edge (mm)
S-M3-1	M3x1	0,97	1	4,25	6,3	4,22	1,5	4,8
S-M4-1	M4x1	0,97	1	5,4	7,9	5,38	2	6,9
S-M5-1	M5x1	0,97	1	6,4	8,7	6,34	2	7,1
S-M6-1	M6x1	1,15	1,2	8,75	11,05	8,72	4,08	8,6
S-M8-1.25	M8x1.25	1,38	1,4	10,5	12,65	10,44	5,47	9,5

CLINCHING THRU-HOLE STANDOFFS

For proper assembly sheet thickness needs to be bigger than sheet thickness on the table. For better assembly do not deburr hole before assembly and press fit from burr side. Distance from hole center to the sheet edge should be higher than table. Default material is Steel with Cr3+ finish.

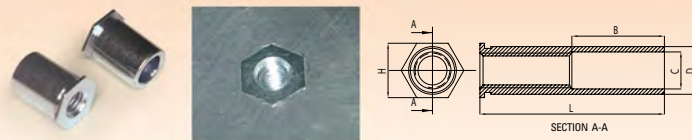

Code	Thread (mm)	L +0.05/-0.13 (mm)	H (Norm)	D -0.13 (mm)	C ±0.13 (mm)	Min.Sheet Thickness (mm)	Rec Hole Size in Sheet +0.08 (mm)	Min. Dist. Hole C/L to Edge (mm)
SO-M3-3	M3x3	3	4,8	4,2	3,2	1,02	4,22	6
SO-M3-4	M3x4	4	4,8	4,2	3,2	1,02	4,22	6
SO-M3-6	M3x6	6	4,8	4,2	3,2	1,02	4,22	6
SO-M3-8	M3x8	8	4,8	4,2	3,2	1,02	4,22	6
SO-M3-10	M3x10	10	4,8	4,2	3,2	1,02	4,22	6
SO-M3-12	M3x12	12	4,8	4,2	3,2	1,02	4,22	6
SO-M3-14	M3x14	14	4,8	4,2	3,2	1,02	4,22	6
SO-M3-16	M3x16	16	4,8	4,2	3,2	1,02	4,22	6
SO-M3-18	M3x18	18	4,8	4,2	3,2	1,02	4,22	6
SO-M4-3	M4x3	3	7,9	7,12	4,8	1,27	7,14	8
SO-M4-4	M4x4	4	7,9	7,12	4,8	1,27	7,14	8
SO-M4-6	M4x6	6	7,9	7,12	4,8	1,27	7,14	8
SO-M4-8	M4x8	8	7,9	7,12	4,8	1,27	7,14	8
SO-M4-10	M4x10	10	7,9	7,12	4,8	1,27	7,14	8
SO-M4-12	M4x12	12	7,9	7,12	4,8	1,27	7,14	8
SO-M4-14	M4x14	14	7,9	7,12	4,8	1,27	7,14	8
SO-M4-16	M4x16	16	7,9	7,12	4,8	1,27	7,14	8
SO-M4-18	M4x18	18	7,9	7,12	4,8	1,27	7,14	8
SO-M4-20	M4x20	20	7,9	7,12	4,8	1,27	7,14	8
SO-M4-22	M4x22	22	7,9	7,12	4,8	1,27	7,14	8
SO-M4-25	M4x25	25	7,9	7,12	4,8	1,27	7,14	8
SO-M5-3	M5x3	3	7,9	7,12	5,35	1,27	7,14	8
SO-M5-4	M5x4	4	7,9	7,12	5,35	1,27	7,14	8
SO-M5-6	M5x6	6	7,9	7,12	5,35	1,27	7,14	8
SO-M5-8	M5x8	8	7,9	7,12	5,35	1,27	7,14	8
SO-M5-10	M5x10	10	7,9	7,12	5,35	1,27	7,14	8
SO-M5-12	M5x12	12	7,9	7,12	5,35	1,27	7,14	8
SO-M5-14	M5x14	14	7,9	7,12	5,35	1,27	7,14	8
SO-M5-16	M5x16	16	7,9	7,12	5,35	1,27	7,14	8
SO-M5-18	M5x18	18	7,9	7,12	5,35	1,27	7,14	8
SO-M5-20	M5x20	20	7,9	7,12	5,35	1,27	7,14	8
SO-M5-22	M5x22	22	7,9	7,12	5,35	1,27	7,14	8
SO-M5-25	M5x25	25	7,9	7,12	5,35	1,27	7,14	8

CLINCHING STUDS

For proper assembly sheet thickness needs to be bigger than sheet thickness on the table. For better assembly do not deburr hole before assembly and press fit from burr side. Distance from hole center to the sheet edge should be higher than table. Default material is Steel with Cr3+ finish.

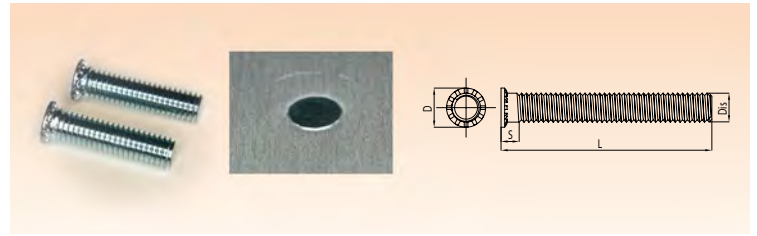

Code	Thread (mm)	L ±0.4 (mm)	D ±0.4 (mm)	S Max.	Min. Sheet Thickness (mm)	Rec Hole Size in Sheet +0.08 (mm)	Max. Hole in Attach Part (mm)	Min. Dist. Hole C/L to Edge (mm)
FH-M3-6	M3x6	6	4,6	2,1	1	3	3,6	5,6
FH-M3-8	M3x8	8	4,6	2,1	1	3	3,6	5,6
FH-M3-10	M3x10	10	4,6	2,1	1	3	3,6	5,6
FH-M3-12	M3x12	12	4,6	2,1	1	3	3,6	5,6
FH-M3-15	M3x15	15	4,6	2,1	1	3	3,6	5,6
FH-M3-18	M3x18	18	4,6	2,1	1	3	3,6	5,6
FH-M3-20	M3x20	20	4,6	2,1	1	3	3,6	5,6
FH-M3-25	M3x25	25	4,6	2,1	1	3	3,6	5,6
FH-M3-30	M3x30	30	4,6	2,1	1	3	3,6	5,6
FH-M4-6	M4x6	6	5,9	2,4	1	4	4,6	7,2
FH-M4-8	M4x8	8	5,9	2,4	1	4	4,6	7,2
FH-M4-10	M4x10	10	5,9	2,4	1	4	4,6	7,2
FH-M4-12	M4x12	12	5,9	2,4	1	4	4,6	7,2
FH-M4-15	M4x15	15	5,9	2,4	1	4	4,6	7,2
FH-M4-18	M4x18	18	5,9	2,4	1	4	4,6	7,2
FH-M4-20	M4x20	20	5,9	2,4	1	4	4,6	7,2
FH-M4-25	M4x25	25	5,9	2,4	1	4	4,6	7,2
FH-M4-30	M4x30	30	5,9	2,4	1	4	4,6	7,2
FH-M4-35	M4x35	35	5,9	2,4	1	4	4,6	7,2
FH-M5-8	M5x8	8	6,5	2,7	1	5	5,6	7,2
FH-M5-10	M5x10	10	6,5	2,7	1	5	5,6	7,2
FH-M5-12	M5x12	12	6,5	2,7	1	5	5,6	7,2
FH-M5-15	M5x15	15	6,5	2,7	1	5	5,6	7,2
FH-M5-18	M5x18	18	6,5	2,7	1	5	5,6	7,2
FH-M5-20	M5x20	20	6,5	2,7	1	5	5,6	7,2
FH-M5-25	M5x25	25	6,5	2,7	1	5	5,6	7,2
FH-M5-30	M5x30	30	6,5	2,7	1	5	5,6	7,2
FH-M5-35	M5x35	35	6,5	2,7	1	5	5,6	7,2
FH-M6-10	M6x10	10	8,2	3	1,6	6	6,6	7,9
FH-M6-12	M6x12	12	8,2	3	1,6	6	6,6	7,9
FH-M6-15	M6x15	15	8,2	3	1,6	6	6,6	7,9
FH-M6-18	M6x18	18	8,2	3	1,6	6	6,6	7,9
FH-M6-20	M6x20	20	8,2	3	1,6	6	6,6	7,9
FH-M6-25	M6x25	25	8,2	3	1,6	6	6,6	7,9
FH-M6-30	M6x30	30	8,2	3	1,6	6	6,6	7,9
FH-M6-35	M6x35	35	8,2	3	1,6	6	6,6	7,9
FH-M8-10	M8x10	10	9,6	3,7	2,4	8	8,6	9,6
FH-M8-12	M8x12	12	9,6	3,7	2,4	8	8,6	9,6
FH-M8-15	M8x15	15	9,6	3,7	2,4	8	8,6	9,6
FH-M8-18	M8x18	18	9,6	3,7	2,4	8	8,6	9,6
FH-M8-20	M8x20	20	9,6	3,7	2,4	8	8,6	9,6
FH-M8-25	M8x25	25	9,6	3,7	2,4	8	8,6	9,6
FH-M8-30	M8x30	30	9,6	3,7	2,4	8	8,6	9,6
FH-M8-35	M8x35	35	9,6	3,7	2,4	8	8,6	9,6



PLASTIC HEADED SCREWS

Code	D	Do	L	S
VD - 640 - 10	4	13	10	6,5
VD - 640 - 15	4	13	15	6,5
VD - 640 - 20	4	13	20	6,5
VD - 640 - 25	4	13	25	6,5
VD - 640 - 30	4	13	30	6,5
VD - 650 - 9	5	18	9	7
VD - 650 - 12	5	16	12	6
VD - 650 - 17	5	16	17	6
VD - 660 - 8	6	25	8	8,65
VD - 660 - 14	6	25	14	8,65
VD - 660 - 18	6	25	18	8,65
VD - 660 - 23	6	25	23	8,65
VD - 660 - 28	6	25	28	8,65
VD - 680 - 8	8	33	8	11
VD - 680 - 14	8	33	14	11
VD - 680 - 18	8	33	18	11
VD - 680 - 23	8	33	23	11
VD - 680 - 28	8	33	28	11

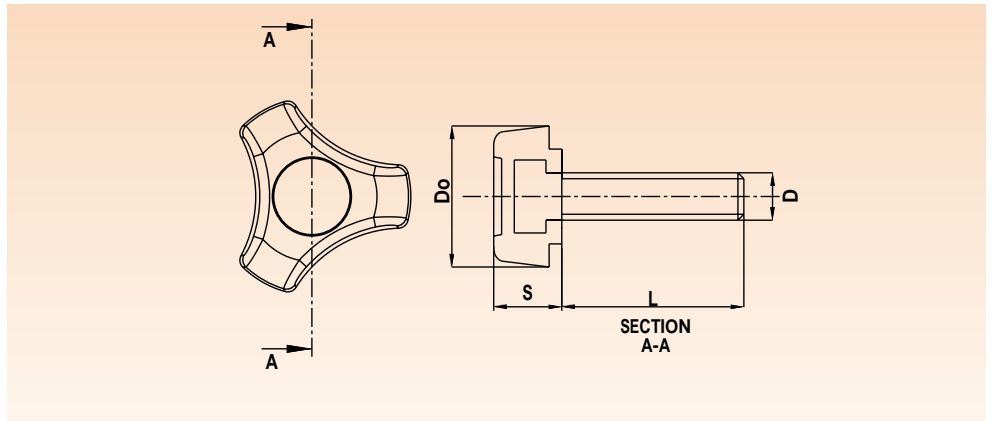

- M4 - M5 - M6 & M8 Plastic headed screws
- ABS material
- Black & white color option



A-662
2,5 x 5 mm YCB PLS
Combo PCB Screw

PACKAGING 500 PCS
COLOR METALIC



A-637
2,2 x 6,5 mm YSB
Screw

PACKAGING 1250 PCS
COLOR BLACK



A-611
2,2 x 6 YSB Screw

PACKAGING 500 PCS
COLOR BLACK



A-617
2,2 x 9,5 mm YHB Screw

PACKAGING 1000 PCS
COLOR METALIC/
BLACK



A-62
2,2 x 13 mm YHB Screw

PACKAGING 500 PCS
COLOR METALIC/
BLACK



A-601
2,9 x 9,5 mm YSB
Screw

PACKAGING 350 PCS
COLOR METALIC



A-635
2,9 x 9,5 YHB Screw

PACKAGING 500 PCS
COLOR METALIC/
BLACK



A-624
2,9 x 25 mm YHB
Screw

PACKAGING 350 PCS
COLOR METALIC/
BLACK

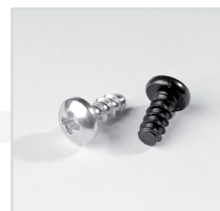

A-618
3 x 6,5 mm PYSB
Screw

PACKAGING 400 PCS
COLOR METALIC/
BLACK



A-614
3 x 9,5 mm PYSB Screw

PACKAGING 300 PCS
COLOR METALIC/
BLACK



A-63
3 x 16 mm PYSB Screw

PACKAGING 500 PCS
COLOR METALIC/
BLACK



A-69
3 x 25 mm YHB
Screw

PACKAGING 300 PCS
COLOR METALIC



A-630
3,5 x 16 PYSB Screw

PACKAGING 350 PCS
COLOR METALIC



A-66
3,5 x 35 mm YHB
Screw

PACKAGING 150 PCS
COLOR METALIC



A-632
2,5 x 5 mm YCB PLS
Combo PCB Screw

PACKAGING 300 PCS
COLOR METALIC



A-622
M3 x 6 mm YSB Screw

PACKAGING 400 PCS
COLOR METALIC



A-656
M3 x 8 mm YSB
Screw

PACKAGING 300 PCS
COLOR METALIC



A-603
M3 x 8 YHB Screw

PACKAGING 500 PCS
COLOR METALIC



A-653
M3 x 12 mm YSB Screw

PACKAGING 500 PCS
COLOR METALIC

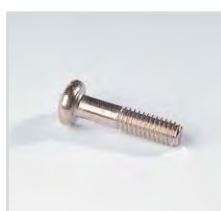

A-648
M4 x 16 CSB
Stainless Screw

PACKAGING 250 PCS
COLOR METALIC

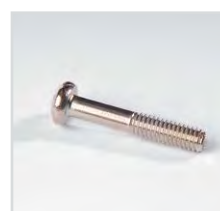

A-665
M4 x 22 mm
CSB Stainless
Screw

PACKAGING 200 PCS
COLOR METALIC



Key Of Turkey

Turkish Trade Hub